

外形尺寸

LTA-204/504

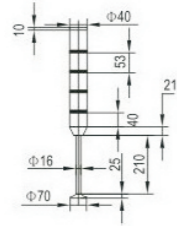

LTA-205/505

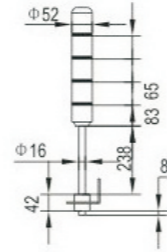

LTA-506

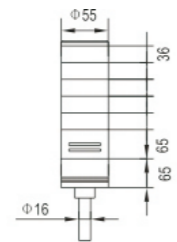

LTA207/507

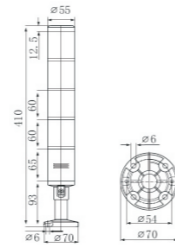

技术参数

型号规格	工作电压	警示功率	光源	颜色
LTA-204 LTA-205 LTA-207	DC12V, 24V; AC110V, 220V	单层: 5W	钨丝灯泡	红 黄 绿 蓝
LTA-504 LTA-505 LTA-506 LTA-507		单层: 1.5 - 3W	LED	白

接线图

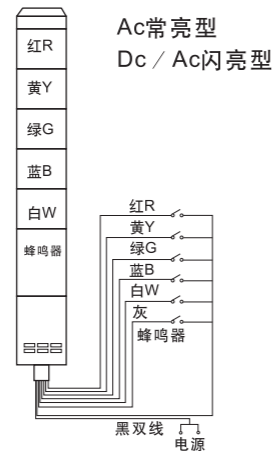
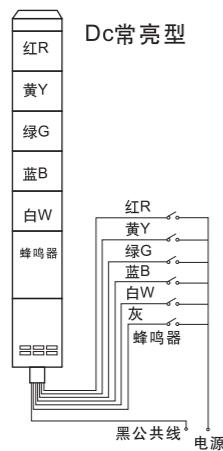

- 优越的外形设计, 能最大程度反应信号灯的亮度, 及延长其寿命
- 多种内置光源可选: 钨丝灯泡、LED灯珠 (节能、亮度高、寿命长)
- 拥有多种型号基座可选, 也可自由搭配组装
- 拥有多种工作模式可选: 常亮 (T)、闪亮 (W)、带蜂鸣器 (J: 85DB)
- 闪光频率: 60 - 80 / min
- 技术认证: CE
- 使用范围: 自动化设备、流水线、机床设备、安防仪器系统等等。
- LED系列公共线, 正负可以根据客户要求而定。(默认为共负极)
- 防护等级: IP65
- 非标可定做。

基座附件

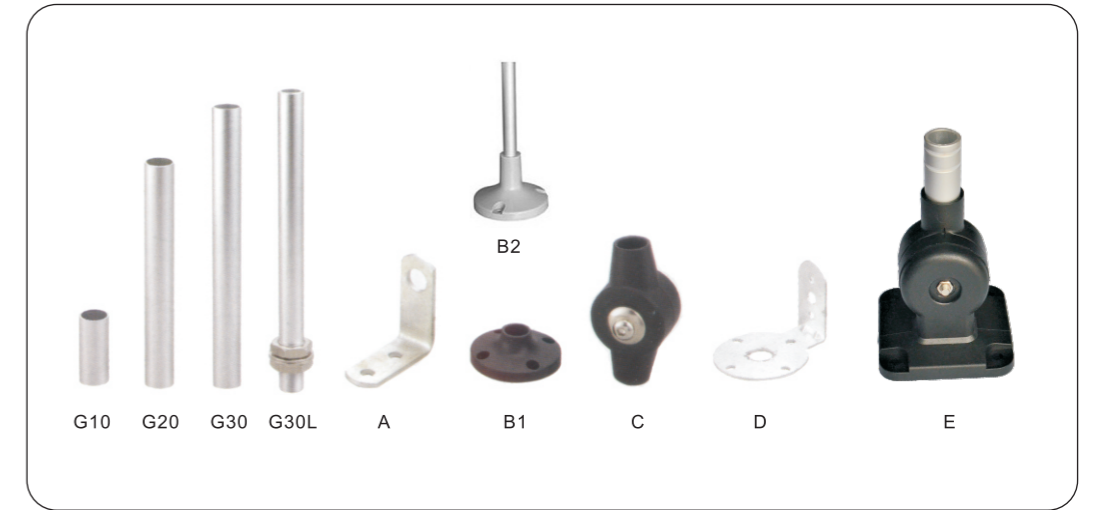

附件可自由搭配



安装组件外形尺寸

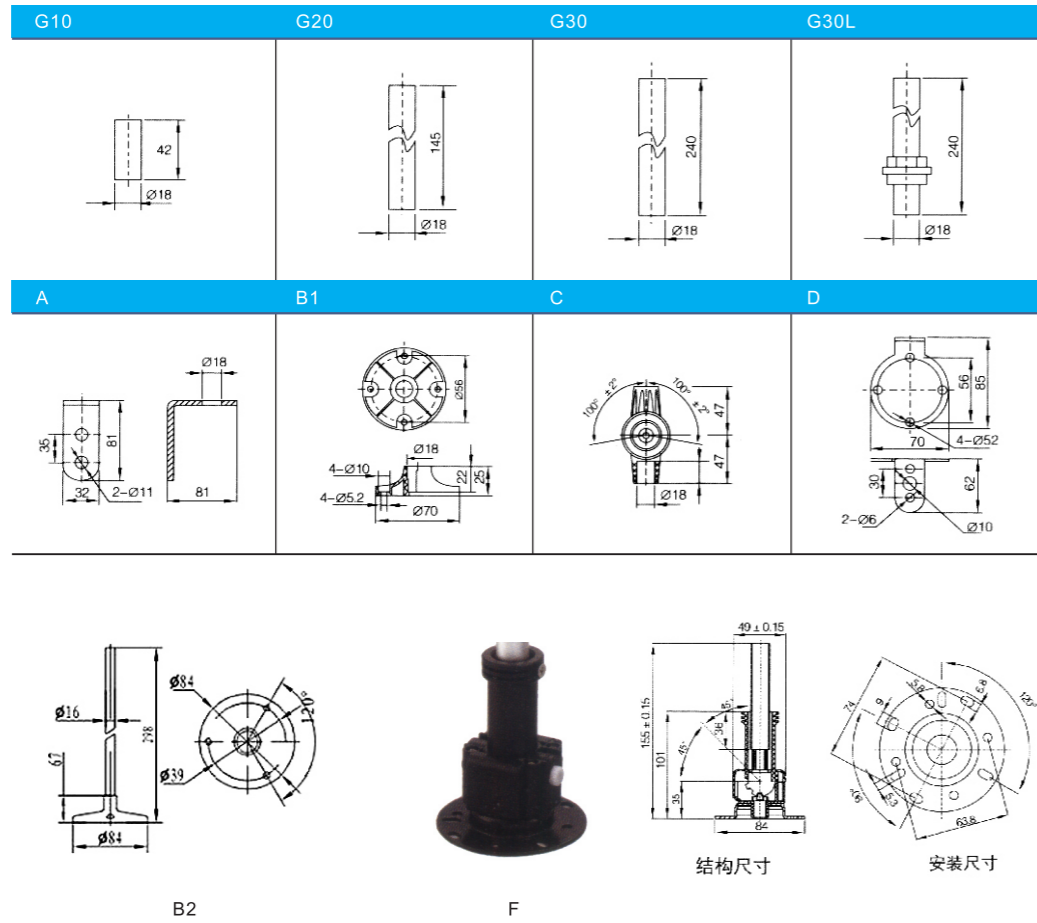



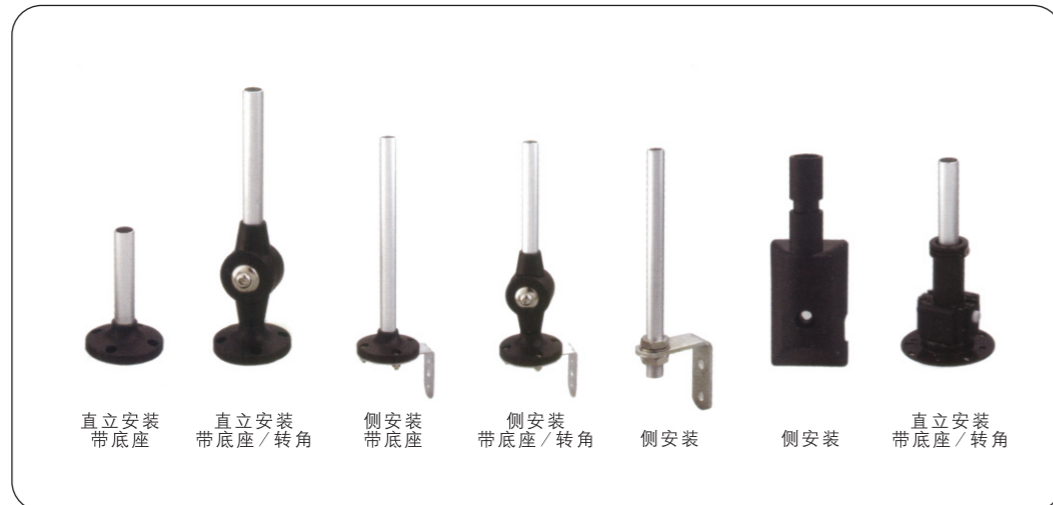





安装方式

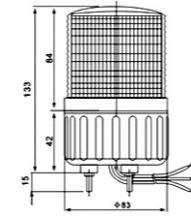

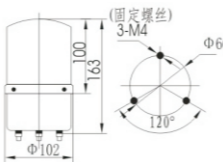

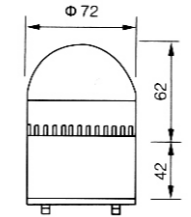

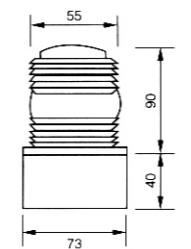

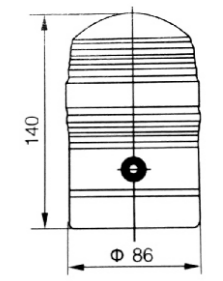

产品图	型号规格	工作电压	警示功率	颜色	外形图
<p>LED/闪亮</p>	LTE-5051 LTE-5051J LTD-5051 LTD-5051J	DC12V, 24V; AC110V, 220V 380V	3W	<div style="display: flex; flex-direction: column; gap: 5px;"> <div style="background-color: red; width: 15px; height: 15px;"></div> <div style="background-color: yellow; width: 15px; height: 15px;"></div> <div style="background-color: green; width: 15px; height: 15px;"></div> <div style="background-color: blue; width: 15px; height: 15px;"></div> </div>	
<p>LED/闪亮</p>	LED-3051	DC12V, 24V; AC110V, 220V 380V	2W	<div style="display: flex; flex-direction: column; gap: 5px;"> <div style="background-color: red; width: 15px; height: 15px;"></div> <div style="background-color: yellow; width: 15px; height: 15px;"></div> <div style="background-color: green; width: 15px; height: 15px;"></div> <div style="background-color: blue; width: 15px; height: 15px;"></div> </div>	
<p>LED/闪亮</p>	LED-3071	DC12V, 24V; AC110V, 220V 380V	2W	<div style="display: flex; flex-direction: column; gap: 5px;"> <div style="background-color: red; width: 15px; height: 15px;"></div> <div style="background-color: yellow; width: 15px; height: 15px;"></div> <div style="background-color: green; width: 15px; height: 15px;"></div> <div style="background-color: blue; width: 15px; height: 15px;"></div> </div>	
<p>LED/闪亮</p>	LED-3072	DC12V, 24V; AC110V, 220V 380V	2W	<div style="display: flex; flex-direction: column; gap: 5px;"> <div style="background-color: red; width: 15px; height: 15px;"></div> <div style="background-color: yellow; width: 15px; height: 15px;"></div> <div style="background-color: green; width: 15px; height: 15px;"></div> <div style="background-color: blue; width: 15px; height: 15px;"></div> </div>	

注: LTE型为螺旋式安装; LTD型为强磁吸附式安装; 型号后带J为带蜂鸣器报警, 不带J则无。
本公司所有产品非标电压可定做。

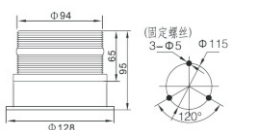
产品图	型号规格	工作电压	警示功率	颜色	外形图
 LED/闪亮 	LTE-80 LTE-80J LTD-80 LTD-80J	DC12V, 24V; AC110V, 220V 380V	3W	<div style="background-color: red; width: 15px; height: 15px; margin-bottom: 2px;"></div> 红 <div style="background-color: yellow; width: 15px; height: 15px; margin-bottom: 2px;"></div> 黄 <div style="background-color: green; width: 15px; height: 15px; margin-bottom: 2px;"></div> 绿 <div style="background-color: blue; width: 15px; height: 15px;"></div> 蓝	
 LED/闪亮 	LTE-100 LTE-100J LTD-100 LTD-100J	DC12V, 24V; AC110V, 220V 380V	3W	<div style="background-color: red; width: 15px; height: 15px; margin-bottom: 2px;"></div> 红 <div style="background-color: yellow; width: 15px; height: 15px; margin-bottom: 2px;"></div> 黄 <div style="background-color: green; width: 15px; height: 15px; margin-bottom: 2px;"></div> 绿 <div style="background-color: blue; width: 15px; height: 15px;"></div> 蓝	
 LED/闪亮 	LTE-5071 LTE-5071J LTD-5071 LTD-5071J	DC12V, 24V; AC110V, 220V 380V	2W	<div style="background-color: red; width: 15px; height: 15px; margin-bottom: 2px;"></div> 红 <div style="background-color: yellow; width: 15px; height: 15px; margin-bottom: 2px;"></div> 黄 <div style="background-color: green; width: 15px; height: 15px; margin-bottom: 2px;"></div> 绿 <div style="background-color: blue; width: 15px; height: 15px;"></div> 蓝	
 LED/闪亮 	LTD-5072	DC6V, (干电池)	2W	<div style="background-color: red; width: 15px; height: 15px; margin-bottom: 2px;"></div> 红 <div style="background-color: yellow; width: 15px; height: 15px;"></div> 黄	

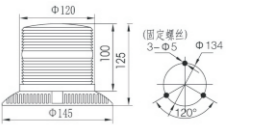
注: LTE型为螺旋式安装; LTD型为强磁吸附式安装; 型号后带J为带蜂鸣器报警, 不带J则无。
本公司所有产品非标电压可定做。

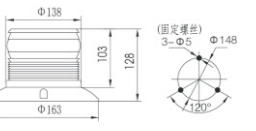
产品图	型号规格	工作电压	警示功率	颜色	外形图
 LED/闪亮 	LTD-5088 LTD-5088J	DC6V, (干电池) DC24V; AC220V,	3W	<div style="background-color: red; width: 15px; height: 15px; margin-bottom: 2px;"></div> 红 <div style="background-color: yellow; width: 15px; height: 15px;"></div> 黄	
 LED/闪亮 	LTD-5188	DC12V, 24V; AC110V, 220V, 380V	3W	<div style="background-color: red; width: 15px; height: 15px; margin-bottom: 2px;"></div> 红 <div style="background-color: yellow; width: 15px; height: 15px; margin-bottom: 2px;"></div> 黄 <div style="background-color: green; width: 15px; height: 15px; margin-bottom: 2px;"></div> 绿 <div style="background-color: blue; width: 15px; height: 15px;"></div> 蓝	
 LED/闪亮 	LTD-5288	DC12V, 24V; AC110V, 220V 380V	5W	<div style="background-color: red; width: 15px; height: 15px; margin-bottom: 2px;"></div> 红 <div style="background-color: yellow; width: 15px; height: 15px; margin-bottom: 2px;"></div> 黄 <div style="background-color: green; width: 15px; height: 15px; margin-bottom: 2px;"></div> 绿 <div style="background-color: blue; width: 15px; height: 15px;"></div> 蓝	
 LED/闪亮 	LTD-5388	DC12V, 24V; AC110V, 220V 380V	5W	<div style="background-color: red; width: 15px; height: 15px; margin-bottom: 2px;"></div> 红 <div style="background-color: yellow; width: 15px; height: 15px; margin-bottom: 2px;"></div> 黄 <div style="background-color: green; width: 15px; height: 15px; margin-bottom: 2px;"></div> 绿 <div style="background-color: blue; width: 15px; height: 15px;"></div> 蓝	

注: LTE型为螺旋式安装; LTD型为强磁吸附式安装; 型号后带J为带蜂鸣器报警, 不带J则无。
本公司所有产品非标电压可定做。

产品图	型号规格	工作电压	警示功率	颜色	外形图
 LED/外八角 	LTE-5101 LTD-5101 LTE-5101J LTD-5101J	DC12V, 24V; AC110V, 220V, 380V	3W	<div style="display: flex; flex-direction: column; align-items: center;"> <div style="width: 15px; height: 15px; background-color: red; margin-bottom: 2px;"></div>红 <div style="width: 15px; height: 15px; background-color: yellow; margin-bottom: 2px;"></div>黄 <div style="width: 15px; height: 15px; background-color: green; margin-bottom: 2px;"></div>绿 <div style="width: 15px; height: 15px; background-color: blue; margin-bottom: 2px;"></div>蓝 </div>	
 LED/内八角 	LTE-5102 LTD-5102 LTE-5102J LTD-5102J	DC12V, 24V; AC110V, 220V, 380V	3W	<div style="display: flex; flex-direction: column; align-items: center;"> <div style="width: 15px; height: 15px; background-color: red; margin-bottom: 2px;"></div>红 <div style="width: 15px; height: 15px; background-color: yellow; margin-bottom: 2px;"></div>黄 <div style="width: 15px; height: 15px; background-color: green; margin-bottom: 2px;"></div>绿 <div style="width: 15px; height: 15px; background-color: blue; margin-bottom: 2px;"></div>蓝 </div>	
 LED/直线形 	LTE-5103 LTD-5103 LTE-5103J LTD-5103J	DC12V, 24V; AC110V, 220V, 380V	3W	<div style="display: flex; flex-direction: column; align-items: center;"> <div style="width: 15px; height: 15px; background-color: red; margin-bottom: 2px;"></div>红 <div style="width: 15px; height: 15px; background-color: yellow; margin-bottom: 2px;"></div>黄 <div style="width: 15px; height: 15px; background-color: green; margin-bottom: 2px;"></div>绿 <div style="width: 15px; height: 15px; background-color: blue; margin-bottom: 2px;"></div>蓝 </div>	
 LED/平圆形 	LTE-5104 LTD-5104 LTE-5104J LTD-5104J	DC12V, 24V; AC110V, 220V, 380V	3W	<div style="display: flex; flex-direction: column; align-items: center;"> <div style="width: 15px; height: 15px; background-color: red; margin-bottom: 2px;"></div>红 <div style="width: 15px; height: 15px; background-color: yellow; margin-bottom: 2px;"></div>黄 <div style="width: 15px; height: 15px; background-color: green; margin-bottom: 2px;"></div>绿 <div style="width: 15px; height: 15px; background-color: blue; margin-bottom: 2px;"></div>蓝 </div>	









注：LTE型为螺旋式安装；LTD型为强磁吸附式安装；型号后带J为带蜂鸣器报警，不带J则无。
本公司所有产品非标电压可定做。

产品图	型号规格	工作电压	警示功率	颜色	外形图
 LED/条纹形 	LTE-5121 LTD-5121 LTE-5121J LTD-5121J	DC12V, 24V; AC110V, 220V, 380V	3W	<div style="display: flex; flex-direction: column; align-items: center;"> <div style="width: 15px; height: 15px; background-color: red; margin-bottom: 2px;"></div>红 <div style="width: 15px; height: 15px; background-color: yellow; margin-bottom: 2px;"></div>黄 <div style="width: 15px; height: 15px; background-color: green; margin-bottom: 2px;"></div>绿 <div style="width: 15px; height: 15px; background-color: blue; margin-bottom: 2px;"></div>蓝 </div>	
 LED/直线形 	LTE-5161 LTD-5161 LTE-5161J LTD-5161J	DC12V, 24V; AC110V, 220V, 380V	5W	<div style="display: flex; flex-direction: column; align-items: center;"> <div style="width: 15px; height: 15px; background-color: red; margin-bottom: 2px;"></div>红 <div style="width: 15px; height: 15px; background-color: yellow; margin-bottom: 2px;"></div>黄 <div style="width: 15px; height: 15px; background-color: green; margin-bottom: 2px;"></div>绿 <div style="width: 15px; height: 15px; background-color: blue; margin-bottom: 2px;"></div>蓝 </div>	
 LED/直线形 	LTE-5181 LTD-5181 LTE-5181J LTD-5181J	DC12V, 24V; AC110V, 220V, 380V	5W	<div style="display: flex; flex-direction: column; align-items: center;"> <div style="width: 15px; height: 15px; background-color: red; margin-bottom: 2px;"></div>红 <div style="width: 15px; height: 15px; background-color: yellow; margin-bottom: 2px;"></div>黄 <div style="width: 15px; height: 15px; background-color: green; margin-bottom: 2px;"></div>绿 <div style="width: 15px; height: 15px; background-color: blue; margin-bottom: 2px;"></div>蓝 </div>	
 LED/太阳能 	LTE-5130	太阳能	2W	<div style="display: flex; flex-direction: column; align-items: center;"> <div style="width: 15px; height: 15px; background-color: red; margin-bottom: 2px;"></div>红 <div style="width: 15px; height: 15px; background-color: yellow; margin-bottom: 2px;"></div>黄 <div style="width: 15px; height: 15px; background-color: green; margin-bottom: 2px;"></div>绿 <div style="width: 15px; height: 15px; background-color: blue; margin-bottom: 2px;"></div>蓝 </div>	

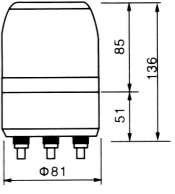

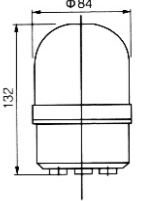

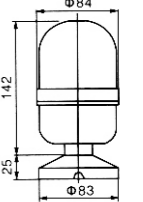

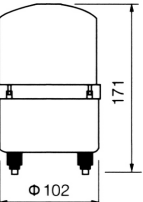

注：LTE型为螺旋式安装；LTD型为强磁吸附式安装；型号后带J为带蜂鸣器报警，不带J则无。
本公司所有产品非标电压可定做。

产品图	型号规格	工作电压	警示功率	颜色	外形图
 氙气管 频闪 	LTE-3051	DC12V, 24V; AC110V, 220V	3W	<div style="display: flex; flex-direction: column; align-items: center;"> <div style="width: 15px; height: 15px; background-color: red; margin-bottom: 2px;"></div>红 <div style="width: 15px; height: 15px; background-color: yellow; margin-bottom: 2px;"></div>黄 <div style="width: 15px; height: 15px; background-color: green; margin-bottom: 2px;"></div>绿 <div style="width: 15px; height: 15px; background-color: blue; margin-bottom: 2px;"></div>蓝 <div style="width: 15px; height: 15px; background-color: white; margin-bottom: 2px;"></div>白 </div>	
 氙气管 频闪 	LTE-3071 LTD-3071	DC12V, 24V; AC110V, 220V	3W	<div style="display: flex; flex-direction: column; align-items: center;"> <div style="width: 15px; height: 15px; background-color: red; margin-bottom: 2px;"></div>红 <div style="width: 15px; height: 15px; background-color: yellow; margin-bottom: 2px;"></div>黄 <div style="width: 15px; height: 15px; background-color: green; margin-bottom: 2px;"></div>绿 <div style="width: 15px; height: 15px; background-color: blue; margin-bottom: 2px;"></div>蓝 <div style="width: 15px; height: 15px; background-color: white; margin-bottom: 2px;"></div>白 </div>	
 氙气管 频闪 	LTE-3072	DC12V, 24V; AC110V, 220V	20W	<div style="display: flex; flex-direction: column; align-items: center;"> <div style="width: 15px; height: 15px; background-color: red; margin-bottom: 2px;"></div>红 <div style="width: 15px; height: 15px; background-color: yellow; margin-bottom: 2px;"></div>黄 <div style="width: 15px; height: 15px; background-color: green; margin-bottom: 2px;"></div>绿 <div style="width: 15px; height: 15px; background-color: blue; margin-bottom: 2px;"></div>蓝 <div style="width: 15px; height: 15px; background-color: white; margin-bottom: 2px;"></div>白 </div>	
 灯泡/转亮 	LTE-2071 LTD-2071 LTE-2071J LTD-2071J	DC12V, 24V; AC110V, 220V	AC: 15W DC: 10W	<div style="display: flex; flex-direction: column; align-items: center;"> <div style="width: 15px; height: 15px; background-color: red; margin-bottom: 2px;"></div>红 <div style="width: 15px; height: 15px; background-color: yellow; margin-bottom: 2px;"></div>黄 <div style="width: 15px; height: 15px; background-color: green; margin-bottom: 2px;"></div>绿 <div style="width: 15px; height: 15px; background-color: blue; margin-bottom: 2px;"></div>蓝 </div>	

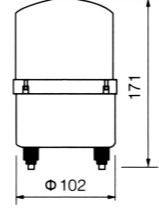
注: LTE型为螺旋式安装; LTD型为强磁吸附式安装; 型号后带J为带蜂鸣器报警, 不带J则无。
本公司所有产品非标电压可定做。

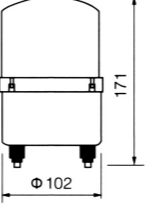
产品图	型号规格	工作电压	警示功率	颜色	外形图
 灯泡/平头形 	LTE-1081 LTD-1081 LTE-1081J LTD-1081J	DC12V, 24V; AC110V, 220V, 380V	5W	<div style="display: flex; flex-direction: column; align-items: center;"> <div style="width: 15px; height: 15px; background-color: red; margin-bottom: 2px;"></div>红 <div style="width: 15px; height: 15px; background-color: yellow; margin-bottom: 2px;"></div>黄 <div style="width: 15px; height: 15px; background-color: green; margin-bottom: 2px;"></div>绿 <div style="width: 15px; height: 15px; background-color: blue; margin-bottom: 2px;"></div>蓝 </div>	
 灯泡/圆头形 	LTE-1082 LTD-1082 LTE-1082J LTD-1082J	DC12V, 24V; AC110V, 220V, 380V	5W	<div style="display: flex; flex-direction: column; align-items: center;"> <div style="width: 15px; height: 15px; background-color: red; margin-bottom: 2px;"></div>红 <div style="width: 15px; height: 15px; background-color: yellow; margin-bottom: 2px;"></div>黄 <div style="width: 15px; height: 15px; background-color: green; margin-bottom: 2px;"></div>绿 <div style="width: 15px; height: 15px; background-color: blue; margin-bottom: 2px;"></div>蓝 </div>	
 灯泡/圆头形 	LTE-1083	DC12V, 24V; AC110V, 220V, 380V	5W	<div style="display: flex; flex-direction: column; align-items: center;"> <div style="width: 15px; height: 15px; background-color: red; margin-bottom: 2px;"></div>红 <div style="width: 15px; height: 15px; background-color: yellow; margin-bottom: 2px;"></div>黄 <div style="width: 15px; height: 15px; background-color: green; margin-bottom: 2px;"></div>绿 <div style="width: 15px; height: 15px; background-color: blue; margin-bottom: 2px;"></div>蓝 </div>	
 灯泡/外八角形 	LTE-1101 LTD-1101 LTE-1101J LTD-1101J	DC12V, 24V; AC110V, 220V, 380V	10W	<div style="display: flex; flex-direction: column; align-items: center;"> <div style="width: 15px; height: 15px; background-color: red; margin-bottom: 2px;"></div>红 <div style="width: 15px; height: 15px; background-color: yellow; margin-bottom: 2px;"></div>黄 <div style="width: 15px; height: 15px; background-color: green; margin-bottom: 2px;"></div>绿 <div style="width: 15px; height: 15px; background-color: blue; margin-bottom: 2px;"></div>蓝 </div>	

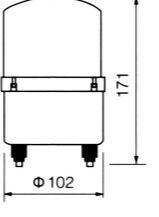
注: LTE型为螺旋式安装; LTD型为强磁吸附式安装; 型号后带J为带蜂鸣器报警, 不带J则无。
本公司所有产品非标电压可定做。

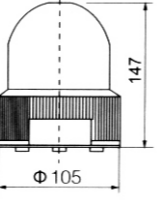





产品图	型号规格	工作电压	警示功率	颜色	外形图
 灯泡/内八角形 	LTE-1102 LTD-1102 LTE-1102J LTD-1102J	DC12V, 24V; AC110V, 220V, 380V	10W	<div style="display: flex; flex-direction: column; align-items: center;"> <div style="width: 15px; height: 15px; background-color: red; margin-bottom: 2px;"></div>红 <div style="width: 15px; height: 15px; background-color: yellow; margin-bottom: 2px;"></div>黄 <div style="width: 15px; height: 15px; background-color: green; margin-bottom: 2px;"></div>绿 <div style="width: 15px; height: 15px; background-color: blue; margin-bottom: 2px;"></div>蓝 </div>	
 灯泡/直线形 	LTE-1103 LTD-1103 LTE-1103J LTD-1103J	DC12V, 24V; AC110V, 220V, 380V	10W	<div style="display: flex; flex-direction: column; align-items: center;"> <div style="width: 15px; height: 15px; background-color: red; margin-bottom: 2px;"></div>红 <div style="width: 15px; height: 15px; background-color: yellow; margin-bottom: 2px;"></div>黄 <div style="width: 15px; height: 15px; background-color: green; margin-bottom: 2px;"></div>绿 <div style="width: 15px; height: 15px; background-color: blue; margin-bottom: 2px;"></div>蓝 </div>	
 灯泡/平面形 	LTE-1104 LTD-1104 LTE-1104J LTD-1104J	DC12V, 24V; AC110V, 220V, 380V	10W	<div style="display: flex; flex-direction: column; align-items: center;"> <div style="width: 15px; height: 15px; background-color: red; margin-bottom: 2px;"></div>红 <div style="width: 15px; height: 15px; background-color: yellow; margin-bottom: 2px;"></div>黄 <div style="width: 15px; height: 15px; background-color: green; margin-bottom: 2px;"></div>绿 <div style="width: 15px; height: 15px; background-color: blue; margin-bottom: 2px;"></div>蓝 </div>	
 灯泡/弹头形 	LTE-1105 LTD-1105 LTE-1105J LTD-1105J	DC12V, 24V; AC110V, 220V, 380V	10W	<div style="display: flex; flex-direction: column; align-items: center;"> <div style="width: 15px; height: 15px; background-color: red; margin-bottom: 2px;"></div>红 <div style="width: 15px; height: 15px; background-color: yellow; margin-bottom: 2px;"></div>黄 <div style="width: 15px; height: 15px; background-color: green; margin-bottom: 2px;"></div>绿 <div style="width: 15px; height: 15px; background-color: blue; margin-bottom: 2px;"></div>蓝 </div>	

注: LTE型为螺旋式安装; LTD型为强磁吸附式安装; 型号后带J为带蜂鸣器报警, 不带J则无。
本公司所有产品非标电压可定做。

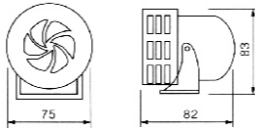

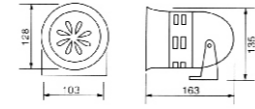

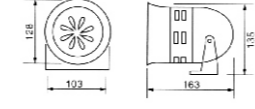

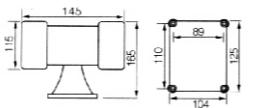
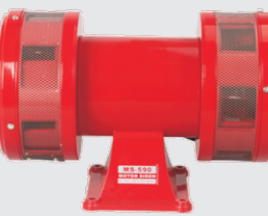
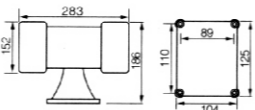
产品图	型号规格	工作电压	警示功率	颜色	外形图
 灯泡/条纹形 	LTE-1121 LTD-1121 LTE-1121J LTD-1121J	DC12V, 24V; AC110V, 220V, 380V	10W	<div style="display: flex; flex-direction: column; align-items: center;"> <div style="width: 15px; height: 15px; background-color: red; margin-bottom: 2px;"></div>红 <div style="width: 15px; height: 15px; background-color: yellow; margin-bottom: 2px;"></div>黄 <div style="width: 15px; height: 15px; background-color: green; margin-bottom: 2px;"></div>绿 <div style="width: 15px; height: 15px; background-color: blue; margin-bottom: 2px;"></div>蓝 </div>	
 灯泡/大弹头形 	LTE-1122 LTD-1122 LTE-1122J LTD-1122J	DC12V, 24V; AC110V, 220V, 380V	10W	<div style="display: flex; flex-direction: column; align-items: center;"> <div style="width: 15px; height: 15px; background-color: red; margin-bottom: 2px;"></div>红 <div style="width: 15px; height: 15px; background-color: yellow; margin-bottom: 2px;"></div>黄 <div style="width: 15px; height: 15px; background-color: green; margin-bottom: 2px;"></div>绿 <div style="width: 15px; height: 15px; background-color: blue; margin-bottom: 2px;"></div>蓝 </div>	
 灯泡/大直线形 	LTE-1161 LTD-1161 LTE-1161J LTD-1161J	DC12V, 24V; AC110V, 220V	AC: 23W DC: 35W	<div style="display: flex; flex-direction: column; align-items: center;"> <div style="width: 15px; height: 15px; background-color: red; margin-bottom: 2px;"></div>红 <div style="width: 15px; height: 15px; background-color: yellow; margin-bottom: 2px;"></div>黄 <div style="width: 15px; height: 15px; background-color: green; margin-bottom: 2px;"></div>绿 <div style="width: 15px; height: 15px; background-color: blue; margin-bottom: 2px;"></div>蓝 </div>	
 灯泡/大平圆形 	LTE-1181 LTD-1181 LTE-1181J LTD-1181J	DC12V, 24V; AC110V, 220V	AC: 23W DC: 35W	<div style="display: flex; flex-direction: column; align-items: center;"> <div style="width: 15px; height: 15px; background-color: red; margin-bottom: 2px;"></div>红 <div style="width: 15px; height: 15px; background-color: yellow; margin-bottom: 2px;"></div>黄 <div style="width: 15px; height: 15px; background-color: green; margin-bottom: 2px;"></div>绿 <div style="width: 15px; height: 15px; background-color: blue; margin-bottom: 2px;"></div>蓝 </div>	



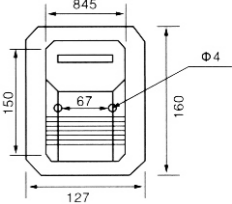

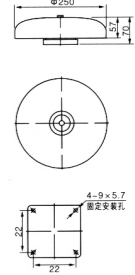

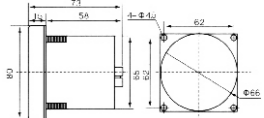
注: LTE型为螺旋式安装; LTD型为强磁吸附式安装; 型号后带J为带蜂鸣器报警, 不带J则无。
本公司所有产品非标电压可定做。

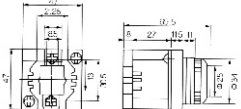
马达 (风螺) (蜂鸣) 警报器系列
Motor (wind bolt) (Feng Ming) alarm series

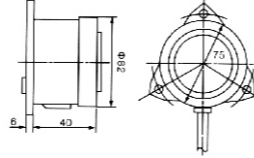
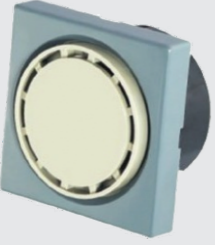
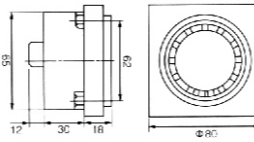
产品图	型号规格	工作电压	声音等级	外壳	外形图
	MS-190	DC12V, 24V; AC110V, 220V	90 - 100dB 半径1米处	金属	
	MS-290	DC12V, 24V; AC110V, 220V	95 - 105dB 半径1米处	塑料/ 金属	
	MS-390	DC12V, 24V; AC110V, 220V	100 - 110dB 半径1米处	金属	
	MS-490	DC12V, 24V; AC110V, 220V	105 - 115dB 半径1米处	金属	
	MS-590	DC12V, 24V; AC110V, 220V	110 - 120dB 半径1米处	金属	

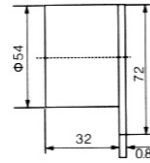
马达 (风螺) (蜂鸣) 安防警报器系列
Motor (wind bolt) (Feng Ming) alarm series

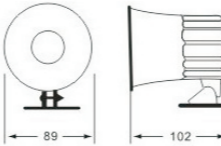







产品图	型号规格	工作电压	声音分贝	安装形式	外形图
	SL-411	DC24V; AC220V	80-90dB 半径1米处	表面安装	
	FA	AC220V		表面安装	
	DL	DC12V, 24V; AC220V	直径: φ 100 φ 150 φ 200	表面安装	
	HRB-P90	DC12V, 24V; AC110V, 220V	90-100dB 半径1米处	嵌入安装	
	HRB-PS30	DC12V, 24V; AC110V, 220V	80-90dB 半径1米处	嵌入安装	

产品图	型号规格	工作电压	声音等级	安装形式	外形图
	HRB-N80	DC12V, 24V; AC110V, 220V	80-90dB 半径1米处	嵌入安装	
	HRB-P80	DC12V, 24V; AC110V, 220V	80-90dB 半径1米处	表面安装	
	BJ-1	DC12V, 24V; AC110V, 220V	90-100dB 半径1米处	表面安装	
	ML-15	DC12V, 24V;	90-100dB 半径1米处	表面安装	
	TS-30D	DC12V, 24V;	90-100dB 半径1米处	表面安装	

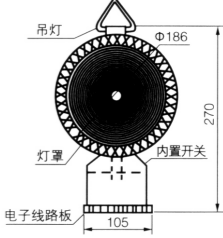
产品图	型号规格	工作电压	声音分贝	安装形式	外形图
	CJB-100RD	DC12V, 24V;		表面安装	
	YH80-1	DC12V, 24V;	110-130dB 半径1米处	表面安装	
产品图	型号规格	工作电压	警示功率	颜色	外形图
	LTG-1084	DC12V,	23W	红 蓝	
	LTG-3093	DC12V, 24V;	30W	红 蓝	

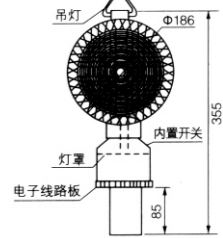
产品图	型号规格	工作电压	警示功率	颜色	外形图
 LED/闪亮 	车载警示灯系列 LTD-1201 LTD-1201J	DC12V, 24V;	35W	<div style="display: flex; flex-direction: column; align-items: center;"> <div style="width: 15px; height: 15px; background-color: red; margin-bottom: 2px;"></div>红 <div style="width: 15px; height: 15px; background-color: yellow; margin-bottom: 2px;"></div>黄 <div style="width: 15px; height: 15px; background-color: green; margin-bottom: 2px;"></div>绿 <div style="width: 15px; height: 15px; background-color: blue; margin-bottom: 2px;"></div>蓝 </div>	
 LED/闪亮 	航空障碍灯系列 TS-1551	AC220V	20-30W	<div style="display: flex; flex-direction: column; align-items: center;"> <div style="width: 15px; height: 15px; background-color: red; margin-bottom: 2px;"></div>红 <div style="width: 15px; height: 15px; background-color: white; margin-bottom: 2px;"></div>白 </div>	
 卤素灯 闪亮 	交通路障警告灯系列 LTE-2181	DC6V	2-5W	<div style="display: flex; flex-direction: column; align-items: center;"> <div style="width: 15px; height: 15px; background-color: red; margin-bottom: 2px;"></div>红 <div style="width: 15px; height: 15px; background-color: yellow; margin-bottom: 2px;"></div>黄 </div>	
 LED/闪亮 	交通路障警告灯系列 LTE-2182	DC3V	2-5W	<div style="display: flex; flex-direction: column; align-items: center;"> <div style="width: 15px; height: 15px; background-color: red; margin-bottom: 2px;"></div>红 <div style="width: 15px; height: 15px; background-color: yellow; margin-bottom: 2px;"></div>黄 </div>	

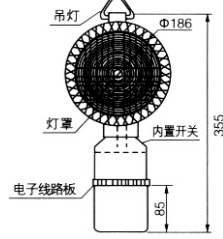
注：LTE型为螺旋式安装；LTD型为强磁吸附式安装；型号后带J为带蜂鸣器报警，不带J则无。
本公司所有产品非标电压可定做。

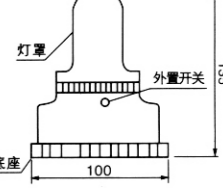
产品图	型号规格	工作电压	警示功率	颜色	外形图
 LED/闪亮 	LTE-2183	DC3V	2-5W	<div style="display: flex; flex-direction: column; align-items: center;"> <div style="width: 15px; height: 15px; background-color: red; margin-bottom: 2px;"></div>红 <div style="width: 15px; height: 15px; background-color: yellow; margin-bottom: 2px;"></div>黄 </div>	
 LED/闪亮 	LTE-2184	DC3V	2-5W	<div style="display: flex; flex-direction: column; align-items: center;"> <div style="width: 15px; height: 15px; background-color: red; margin-bottom: 2px;"></div>红 <div style="width: 15px; height: 15px; background-color: yellow; margin-bottom: 2px;"></div>黄 </div>	
 LED/闪亮 	LTE-2185	DC6V	2-5W	<div style="display: flex; flex-direction: column; align-items: center;"> <div style="width: 15px; height: 15px; background-color: red; margin-bottom: 2px;"></div>红 <div style="width: 15px; height: 15px; background-color: yellow; margin-bottom: 2px;"></div>黄 </div>	
 LED/闪亮 	LTE-2063	DC3V	2-5W	<div style="display: flex; flex-direction: column; align-items: center;"> <div style="width: 15px; height: 15px; background-color: red; margin-bottom: 2px;"></div>红 <div style="width: 15px; height: 15px; background-color: yellow; margin-bottom: 2px;"></div>黄 </div>	

注：LTE型为螺旋式安装；LTD型为强磁吸附式安装；型号后带J为带蜂鸣器报警，不带J则无。
本公司所有产品非标电压可定做。