



# **XC series BD board for special functions**

**Operate Manual**

Xinje Electronic Co., Ltd.



# Catalog

<b>1. CONFIGURE METHOD OF BD BOARD .....</b>	<b>1</b>
<b>2. ANALOG INPUT AND TEMPERATURE SAMPLING BOARD XC-2AD2PT-BD .....</b>	<b>2</b>
<b>3. ANALOG I/O EXPANSION BD BOARD XC-2AD2DA-BD.....</b>	<b>9</b>
<b>4. COMMUNICATION EXTEND CARD XC-COM-BD.....</b>	<b>13</b>
<b>5. XC-SD-BD FOR SD CARD.....</b>	<b>15</b>
<b>6. ETHERNET EXPANSION BOARD XC-TBOX-BD .....</b>	<b>27</b>
<b>7. WEIGHING EXPANSION BD XC-WT-BD .....</b>	<b>37</b>
<b>8. FIBER OPTICAL COMMUNICATION EXPANSION BD XC-OFC-BD .....</b>	<b>41</b>
<b>9. PROFIBUS EXPANSION BD BOARD XC-PBOX-BD.....</b>	<b>45</b>



## 1. Configure method of BD board

### Configure method of BD board:

- 1) Install BD board correctly to the main unit;
- 2) Then, online with XCP edit tool, in “Window” menu, chose “Configure BD Board” (see graph 1)
- 3) Then, in “BD Board Configure”, choose “Other BD” (see graph 2), download user program.

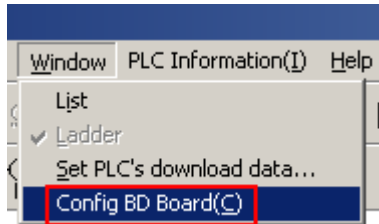

Graph1

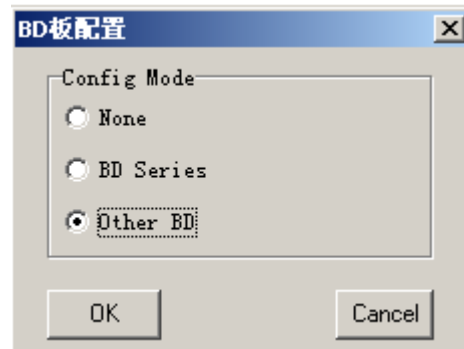

Graph2

## 2. Analog input and temperature sampling board XC-2AD2PT-BD

### 1、Characteristic:

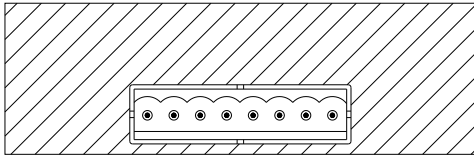

- 14 bits high precise analog input.
- 2 channels voltage 0~10V、0~5V selective, 2 channels temperature analog input.
- Platinum temperature testing resistor (Pt100 two-line format), temperature sensor using analog input.

### 2、General Specification

Item	Voltage input	Temperature input
Analog input signal	DC0~5V、0~10V (Input resistor 300k $\Omega$ )	Platinum resistor Pt100 (2-line format)
Temperature testing bound	-	-100~350 $^{\circ}$ C
Distinguish ratio	0.15mV (10/16383)	0.1 $^{\circ}$ C
Digital output bound	0~16383	-1000~3500
Colligate precision	$\pm 0.8\%$ of the full-scale	
Convert time	15ms $\times$ 4 channels	
PID output value	0~K4095	
No-load defaulted value	0	3500
Input characteristic		
Insulation	No insulation between each channel of PLC	
I/O engross	0 I/O (Since it is operated via data register, so it is not limited by main PLC's standard max. control points)	

### 3、 External installation and connection

1) Installation method of expansion board:

Open the cover in the left of PLC (see the following dashed line), then insert the board to the PLC according to the pins, fix with the screws, close the PLC cover to finish.

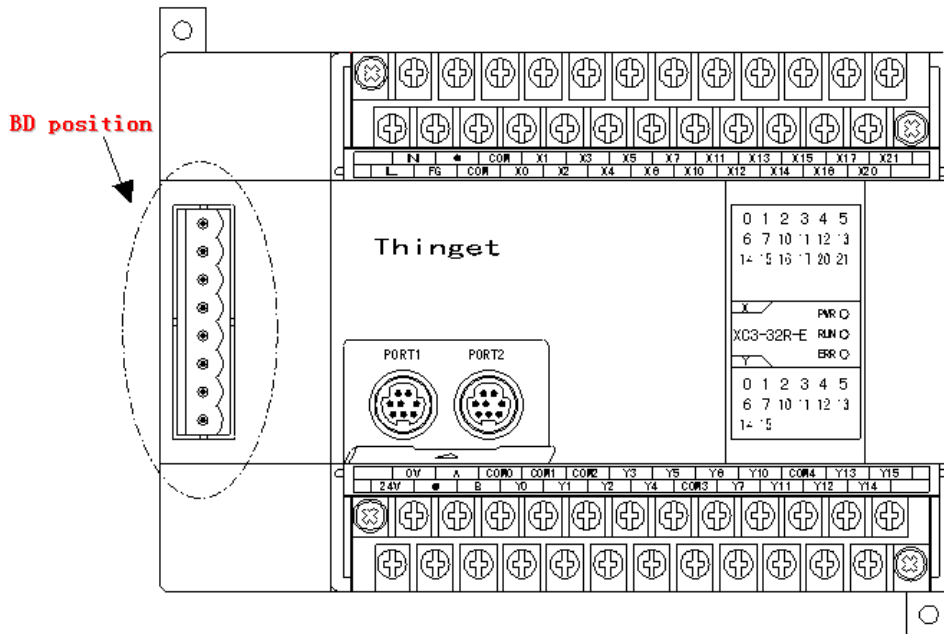

2) Connection method: See the following graph

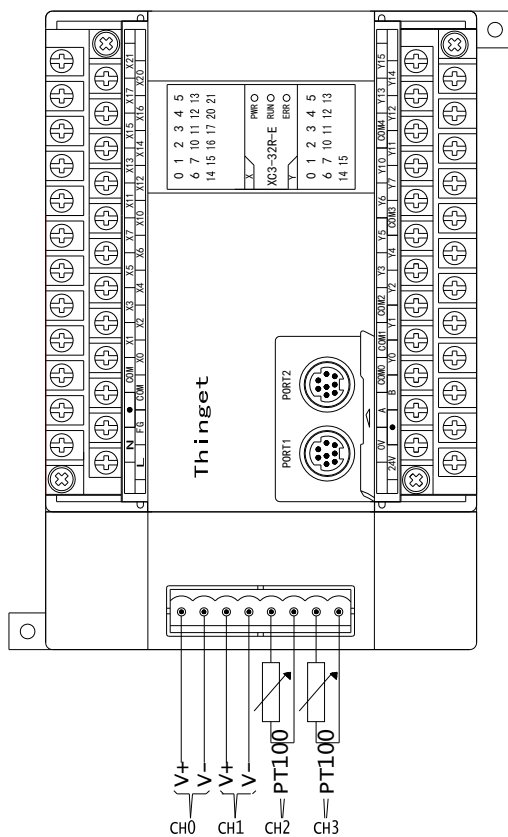

## 4、 Distribution of input define ID

This BD board doesn't engross any I/O unit, the converted value will be sent to PLC register directly, the channel's correspond PLC register ID is:

Channel's ID	AD signal/temperature	PID output value	The set data/temperature	Kp	Ki	Kd	Diff	Death	start/stop
0CH	ID1000	ID1004	QD1000	QD1004	QD1005	QD1006	QD1007	QD1008	Y1000
1CH	ID1001	ID1005	QD1001						Y1001
2CH	ID1002	ID1006	QD1002	QD1009	QD1010	QD1011	QD1012	-	Y1002
3CH	ID1003	ID1007	QD1003						Y1003

### Description:

- 1) 0CH、1CH are AD input channels; 2CH、3CH are Pt input channels.
- 2) Kp: proportion parameters; Ki: integral parameter; Kd: differential parameters; Diff: control bound  
Control bound Diff: in the assigned bound, carry on PID control, beyond that bound, don't carry on that control  
Start signal (Y): if Y is 0, close PID control, if Y is 1, start PID control.  
Death bound Death: it means the current PID control value compares with the preceding PID control value, if the difference between them is less than the set bound of death, the module will abandon the current PID control value, send the preceding PID control value to the PLC main unit.

## 3. Setting of working mode

- 1) For expansion's input/output, they both have option of voltage 0~5V、0~10V, current 0~20mA、4~20mA modes and sieve format. Setting via special FLASH data register FD. See the left graph:

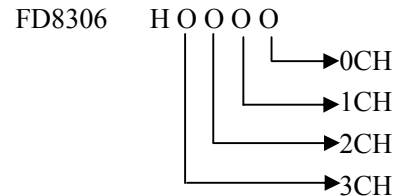

- 2) Each channel's working mode is assigned by 4 bits in the correspond register. Each bit's definition is shown below:

Register FD8306:



Channel 1				Channel 0			
Bit7	Bit6	Bit5	Bit4	Bit3	Bit2	Bit1	Bit0
00: 1/2 sieve		-	0:0~10V	00: 1/2 sieve		-	0:0~10V
01: not sieve			1:0~5V	01: not sieve			1:0~5V
10: 1/3 sieve			-	10: 1/3 sieve			-
11: 1/4 sieve			-	11: 1/4 sieve			-
Channel 3				Channel 2			
Bit15	Bit14	Bit13	Bit12	Bit11	Bit10	Bit9	Bit8
00: 1/2 sieve		-	-	00: 1/2 sieve		-	-
01: not sieve				01: not sieve			
10: 1/3 sieve				10: 1/3 sieve			
11: 1/4 sieve				11: 1/4 sieve			

## 5、 Control specification

- 1) Usage of the four parameters: proportion parameter (Kp)、integral parameter (Ki)、differential parameter (Kd)、control proportion band (Diff) .
- a.) Parameter P is proportion parameter, mainly reflect system's difference, as soon as the difference occurs, carry on control to decrease the difference.
  - b.) Parameter I is integral parameter, mainly used to remove the whisht difference, improve the system's no difference degree.
  - c.) Parameter D is differential parameter, mainly used to control signal's changing trend, decrease the shake of system.

Temperature control bound means: in the assigned bound, carry on PID control, beyond this bound, don't go on PID control.

### 2) Control specification

The PID regulate bound is (QD-Diff, QD+Diff) , when the temperaure is below QD-Diff,the controller heat up ,when the temperature is higher than QD+Diff, the controller stop heating.

Temperature-control curve of PID:

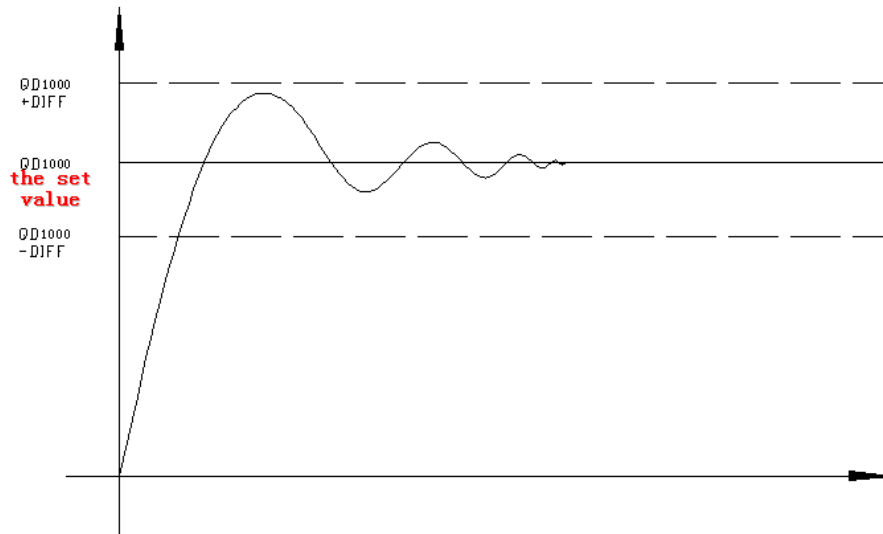

- 3) Each parameter's reference value:  $K_p=20\sim100$ ;  $K_i=5\sim20$ ;  $K_d=200\sim800$ ;  $DIFF=100\sim200$ ;  
 These reference values are only used for normal condition's reference, according to the field's detailed condition, each parameter's value could be set beyond the set bound.

## 6、 Application of PID output value

When carry on temperature PID regulation, the module will output a PID control value every 2 seconds. So, in the PLC program, we could carry on heat control with the duty ratio formed by PID output vale and K4095 in 2 seconds! Assume PID output value is  $X(0\leq X\leq 4095)$ , in the cycle of 2 seconds, carry on duty ratio control,  $2X/4095$  seconds heater output,  $(2-2X/4095)$  seconds heater close output.

## 7、 Program

E.g.1、 real time read data of channel 0, and carry on PID adjustment of channel 0.

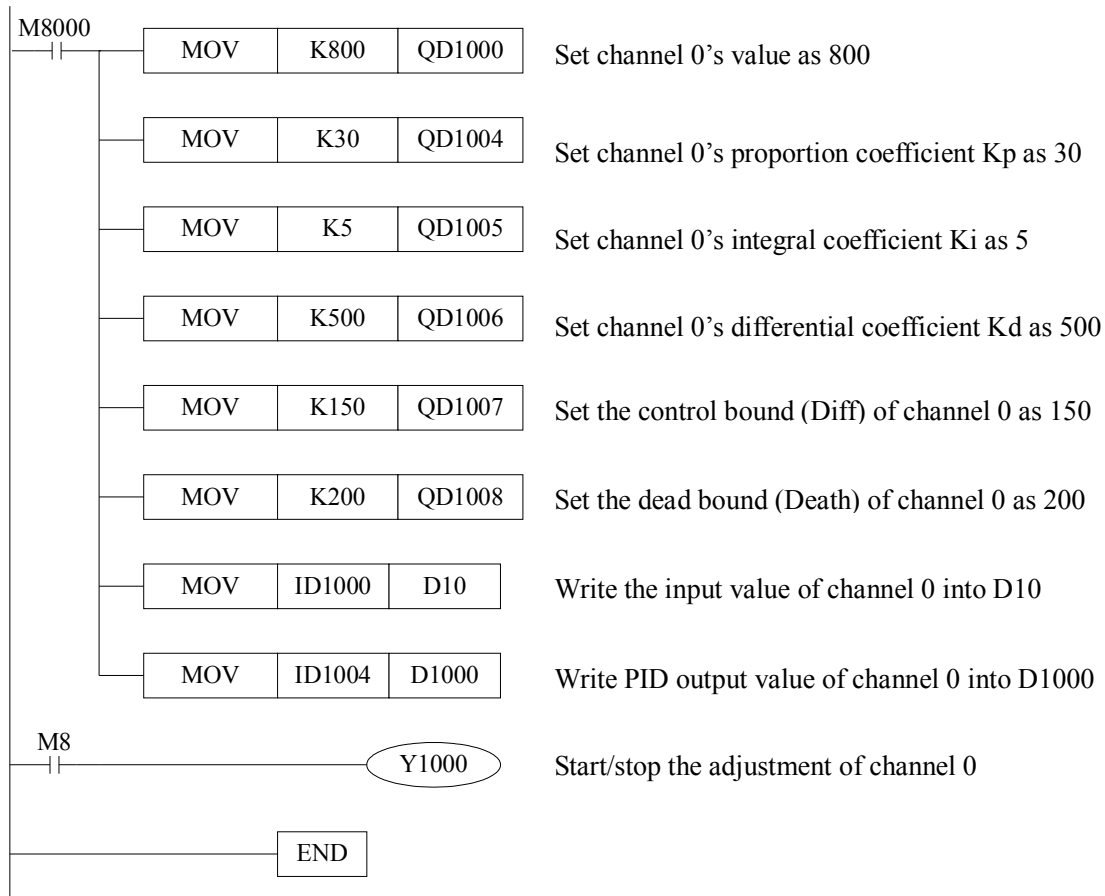

E.g.2、 example of PID temperature control

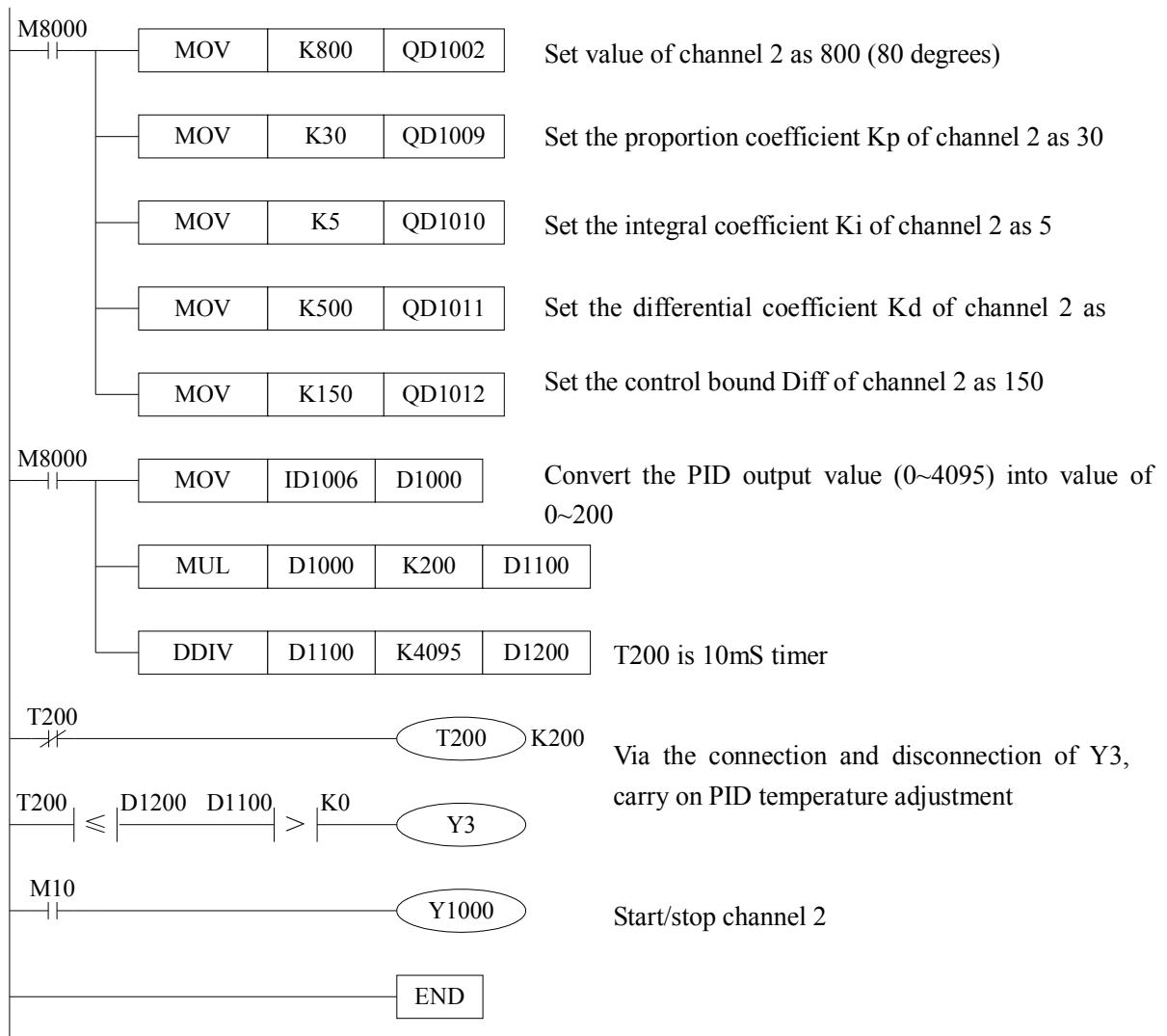

### 3. Analog I/O expansion BD board XC-2AD2DA-BD

#### 1. Characteristics

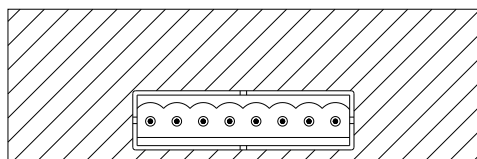

- 14 bits high precision analog input
- 10 bits high precision analog output
- 2 channels 0-10V, 0-5V voltage input choices
- 2 channels 0-20mA, 4-20mA current output choices

#### 2. General specifications

Item	Voltage input	Current output
Analog input range	DC0~5V, 0~10V(input resistor 300k $\Omega$ )	-
Analog output range	-	DC0~20mA、4~20mA (external load resistor is less than 500 $\Omega$ )
Resolution	1/16383(14Bit); the transformed data is saved as hex in the PLC	1/1023(10Bit); the transformed data is saved as hex in the PLC
Digital output range	14 bits binary data (0~16383)	-
Digital input range	-	10 bits binary data (0~1023)
Integrated precision	$\pm 0.8\%$ of the full scale	
Transformation time	15ms $\times$ 2 channel	3ms/1 channel
PID output value	0~K1023	-
Insulation	There is no insulation among each PLC channel	
I/O occupy	0 point (the module operate the data via PLC registers, it will not be limited by PLC max I/O points)	

#### 3. Connection and Installation

##### (1) Installation:

Open the cover on the left side of PLC, insert the expansion BD board into the pins, then fix it with the screw, then close the cover.

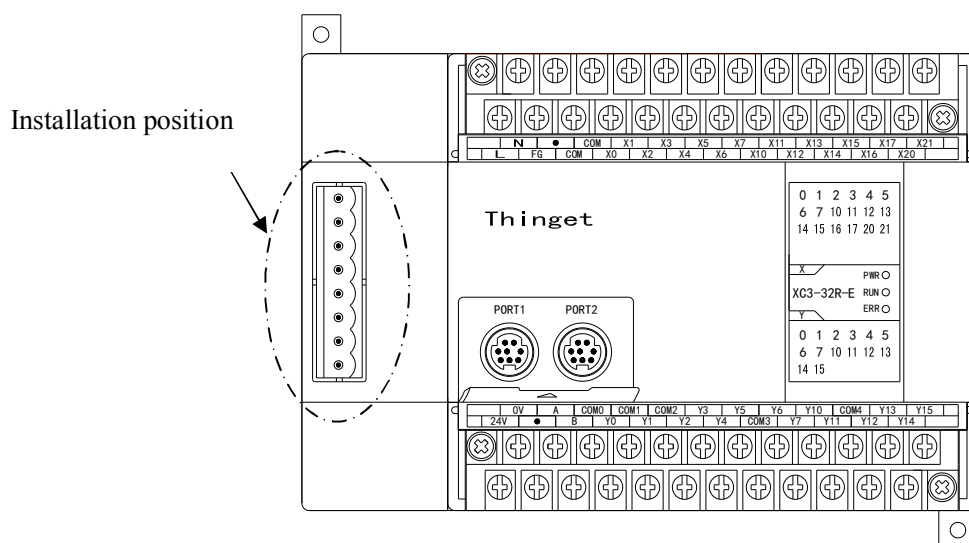

(2) Connection:

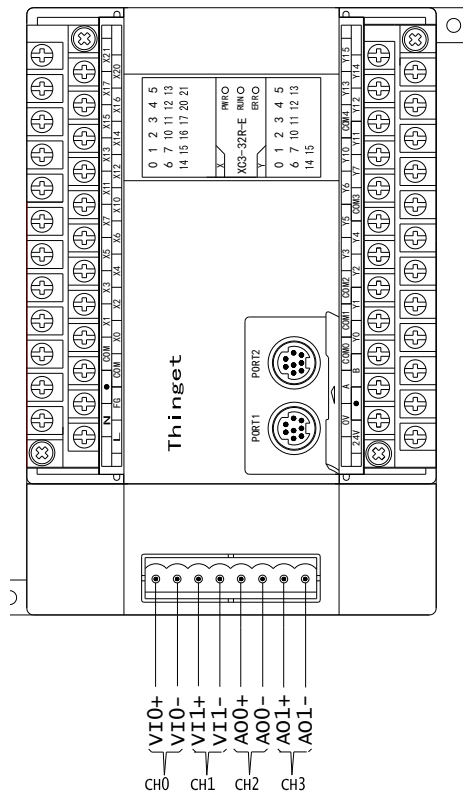

#### 4. I/O address assignment

The BD board will not occupy I/O space, the transformed data will be saved in PLC registers. The PLC registers are as the following:

Channel	AD signal	PID output	PID control bit	Set value	PID parameters: Kp, Ki, Kd, Diff, Death
0CH	ID1000	ID1002	Y1000	QD1002	Kp----QD1004; Ki----QD1005; Kd----QD1006; Diff---QD1007; Death--QD1008
1CH	ID1001	ID1003	Y1001	QD1003	
Channel	DA signal	-	-	-	-
0CH	QD1000	-	-	-	
1CH	QD1001	-	-	-	

#### Notes:

1) 0CH, 1CH are AD input channels; 2CH, 3CH are DA output channels.

2) Kp: proportion, Ki: integral, Kd: differential, Diff: control range

Diff: to do PID control in appointed area.

PID control bit (Y): Y=0, PID control is unable; Y= 1, PID control is able.

Death: to compare the former and the current PID control value, if the difference is less than death area, the module will abandon the current PID control value and send the former value into the PLC.

## 5. Working mode

1) The expansion BD board has 0-5V and 0-10V voltage input choices; 0-20mA, 4-20mA current output choices. They can be set by FLASH register in the PLC. As the right diagram showing, each register can decide the modes of 4 channels. Every 4 bits of the register can decide one channel's mode.

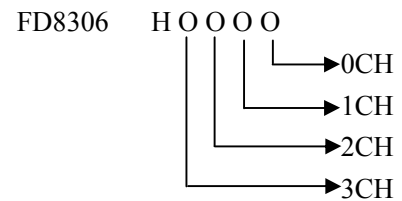

2) One register has 16 bits, every 4 bits can decide one channel's working mode.

Register FD8306:

Channel 1				Channel 0			
Bit7	Bit6	Bit5	Bit4	Bit3	Bit2	Bit1	Bit0
00: 1/2 filter		-	0: 0~10V	00: 1/2 filter		-	0: 0~10V
01: no filter			1: 0~5V	01: no filter			1: 0~5V
10: 1/3 filter			-	10: 1/3 filter			-
11: 1/4 filter			-	11: 1/4 filter			-
Channel 3				Channel 2			
Bit15	Bit14	Bit13	Bit12	Bit11	Bit10	Bit9	Bit8
-		-	0: 0~20mA	-		-	0: 0~20mA
-		-	1: 4~20mA	-		-	1: 4~20mA

## 6. AD transformation diagram

The relationship between input analog and transformed digital data:

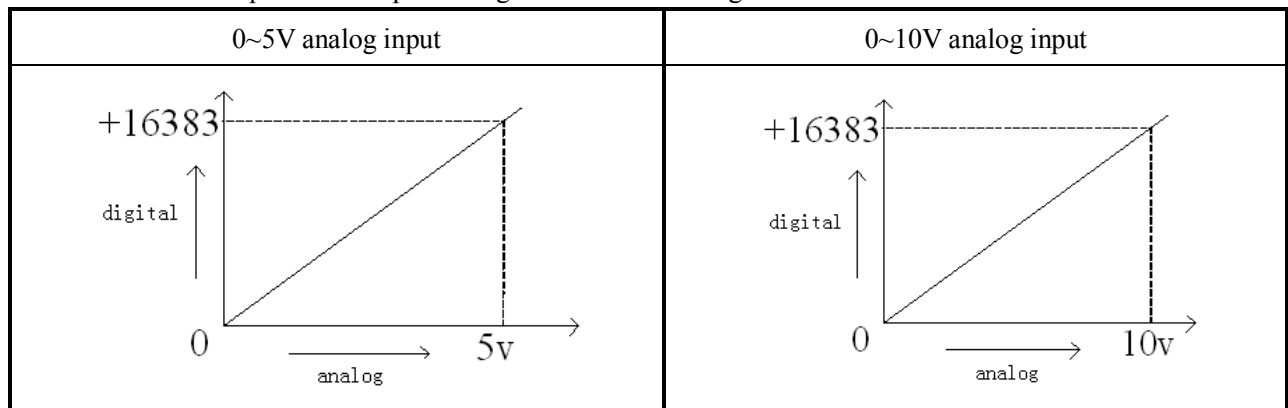

The relationship between input digital and transformed analog data:

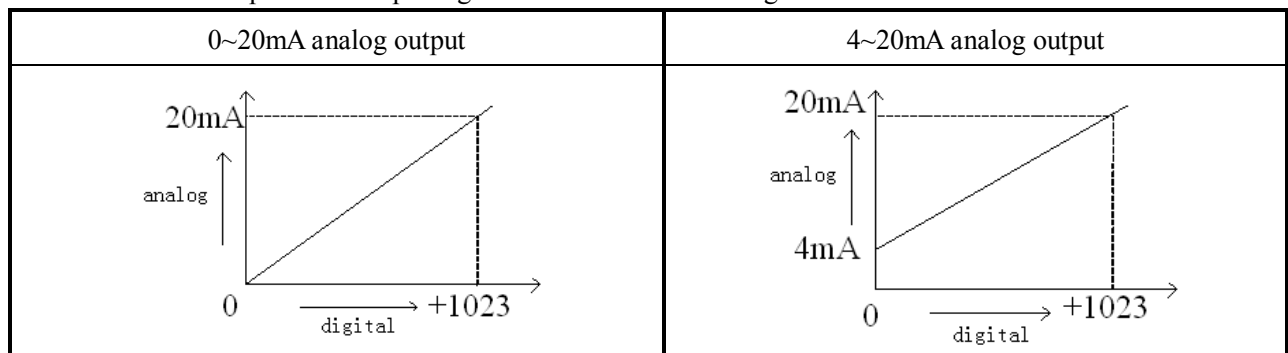

**Note:** If the output data is more than K1023, D/A result will be 20mA.

## 7. Example

Read the real time data of 2 channels; write the data in 2 channels.

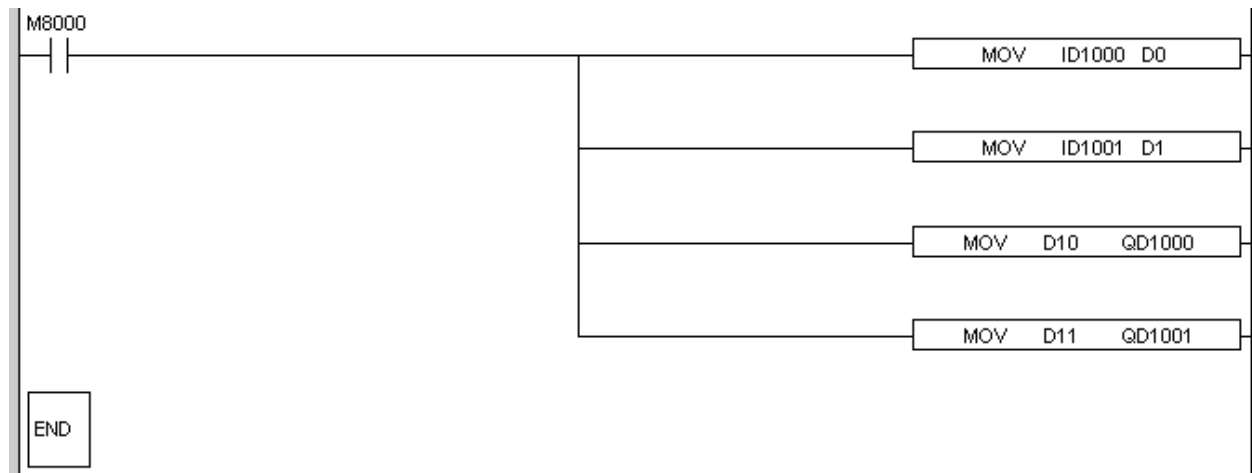

### Explanation:

M8000 is always ON when PLC is running.

When PLC is running, it writes the channel 0 data of model 1 to register D0 of PLC.

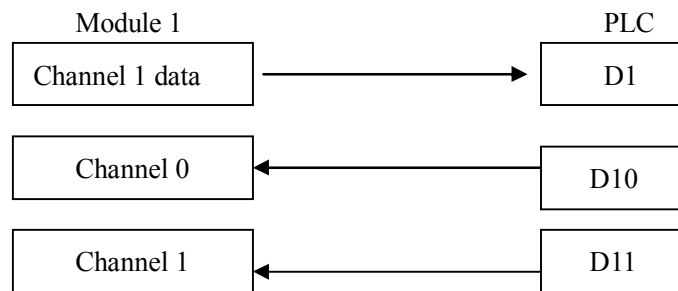



## 4. Communication extend card XC-COM-BD

### 1、Characteristic

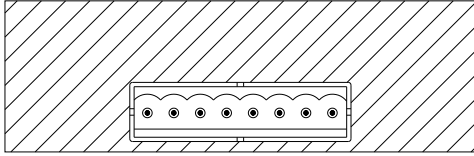

- RS485 communication port
- RS232 communication port
- RS485 and RS232 can not be used at the same time

### 2、Installation and connection

#### 1) Installation:

Open the PLC cover on the left, insert the card into the pins, fix it with screw and close the cover.

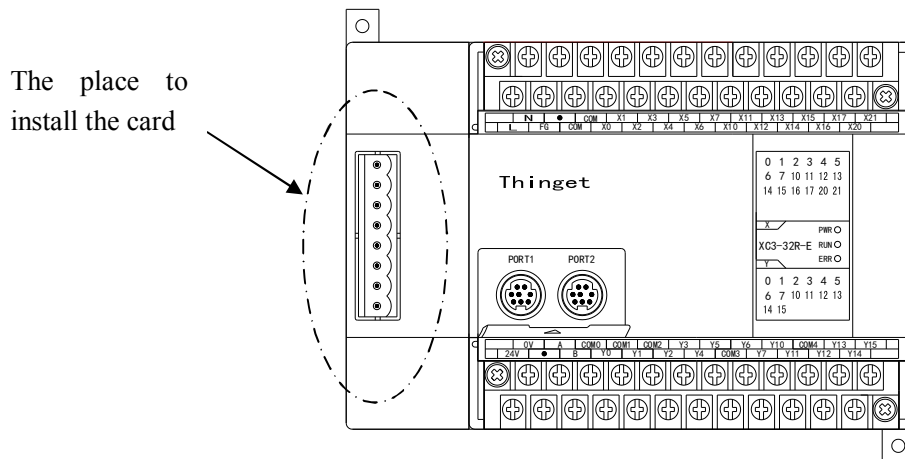

#### 2) Connection:

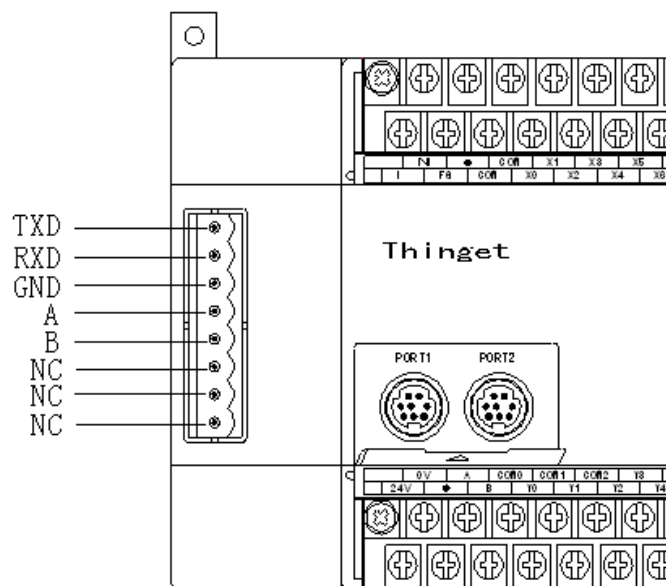

Notes:

- (1) TXD, RXD, GND are RS232 communication port.
- (2) A, B are RS485 communication port.
- (3) RS232 and RS485 can not be used at the same time.

### 3、XC software setting

When using the BD board, please select the BD serial port in the XCPpro software:

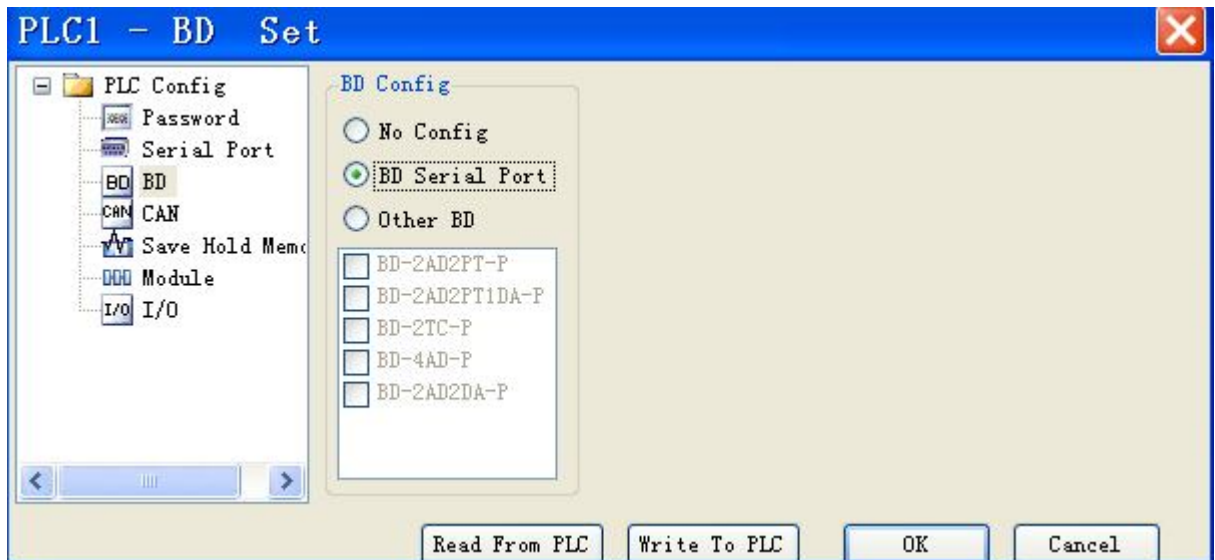

## 5. XC-SD-BD for SD card

### 1. Characteristic

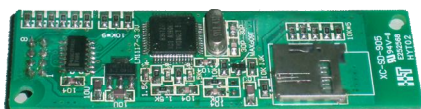

- To install SD card and expand the XC memory
- PLC can read and write the data of SD card
- Support 4 data formats ( single word, double word, float, character )
- XC hardware version V3.2 and above is required

### 2. Explanation

#### 1) SD card

- XC-SD-BD has not been installed the SD card when out of factory, user needs to prepare MicroSD ( TF card ), the card memory should be not more than 2GB.
- Before install the SD card in the XC-SD-BD, please use card reader to format the SD to FAT16 in the PC.
- SD card supports hot plug, but please wait for at least 5 second after hot plug.



#### 2) The file standard in SD card

- SD card supports .csv file, these file should be saved in the root directory.
- All the .csv files must be named as dataxxx.csv, xxx is the file index number, the range is 001~999, when xxx is less than 100, add 0 from the left side. For example, if file index number is 1, the file name will be data001.csv.

#### 3) Data format and type in SD card

- SD card supports 4 kinds of data type: single word (W), double word (DW), float(Fm.n), character (Sx).
- The data range and space:

Data type	W	DW	Fm.n(m<=15,n<=15)	Sx(x<=16)
Data range	-32768~ 32767	-2147483648~ 2147483647	-18446742974197923840~ 18446742974197923840	\
Character occupied in SD card	6	11	m+1+n	2*x
WORD number	1	2	2	x

#### NOTE:

- (1) When the real data length is less than the character length in SD card, add space from the left side. For example, single word data 454, data type is W, character length is 6, so add 6-3 = 3 spaces. The real number is `454`. (  is space ).
- (2) When Fm.n is negative number, the sign bit occupies one character. For example, F5.3, after writing the number -12345.123 in SD card, the lowest valid bit will be deleted; the number will become -12345.12.
- (3) The x of character Sx means word length, but not character length.

### 3. Operation for the SD

XC series PLC can connect SD card, write and read the data from the SD card.

#### 1) Read the SD card

After installing the SD card successfully, PLC can read the SD card data. Use FROM instruction to read the appointed data block in .csv file of SD card.

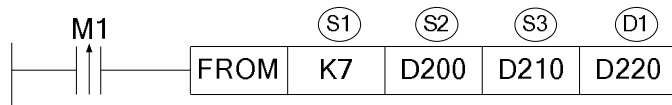

- Read the data from SD card to PLC, unit is word.
- S1: K7 means the object is XC-SD-BD.
- S2~S2+2: appoint .csv file index number, the column head address of data block, the row head address of data block. Operand is D.

In the example, D200 is the .csv file index number

D201 is the column head address of the data block

D202 is the row head address of the data block

- S3: the word numbers you want to read out. Operand is D.
- D1: save the data in PLC register. Operand is D.

In this example, if D200=2, D201=1, D202=3, D210=3. The instruction will do like this: read 3 numbers start from column 1, row 2 of the file “data002.csv” in SD card, and save it in D220 of PLC.

If the data002.csv is shown as the following, then the numbers in the red color line will be read.

w, dw, s8, f4.15, dw, w, dw					
2980,	178605,	HFASDFNQWEJFN,	769.467894,	-1321240,	-330, 780240
2471,	-191280,	JKSAHDKFHAKLS,	830.26683,	-2515275,	-23782, -665320
9628,	39984,	jakjfkdakl,	387.56305,	458388,	-7728, -884013
9045,	-251190,	testh,	949.899791,	-417510,	39600, 195264
1824,	141351,	hellbaby,	408.248854,	2644828,	-1836, 558904
22300,	70153,	testh,	570.088499,	-583542,	-6534, 1095926
-1742,	271975,	HSDKLJDF,	162.57849,	-1238233,	-25761, -125260
1636,	207536,	JSKDJFDSALF,	735.422261,	293940,	2400, 345495
9962,	37107,	HDJNFCJDSNC,	860.864485,	538920,	24660, 827472

### Explanation:

- (1) In the data002.csv file, the first line is data type definition; this line is included in the row address.
- (2) The number “2471” is W type, “-191280” is DW type, so totally 3 words, the same as the read out word numbers.

## 2) Write SD card

By TO instruction, PLC can write the data into appointed location in .csv file of SD card. Please note that user must build a .csv file in the SD card at first, and define the write in data type in the .csv file. If not, the ERROR LED of XC-SD-BD will be always ON.

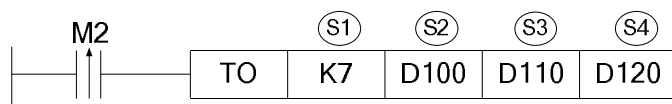

- Write the appointed data block of PLC in the SD card .csv file. Unit is word.
- S1: K7 means the object is XC-SD-BD.
- S2~S2+2: appoint the .csv file index number, the column and row address of data block. Operand is D.

In the instruction, D100 is the index number of the .csv file

D101 is the column address of the data block

D102 is the row address of the data block

- S3: the word numbers need to write in the SD card. Operand is D.
- S4: the PLC register head address need to write into the SD card. Operand is D.

In the instruction, if D100=1, D101=1, D102=2, D110=5, D120=365, D121=10235465, D123=26456. So the data will be written in data001.csv is in the red color range:

```
w, dw, dw, f4. 15,
365, 10235465, 26456, 769.467894,
2471, -191280, 70153, 830.26683,
```

**NOTE:** the write in data type should be the same as the .csv file data type. If not, the ID1000 will be error.

### 3) Notice

- Character type Sx
  - A. Sx supports visible character such as letter, number, the same as ASCII code [32,126], but not support comma “,”.
  - B. Invisible character, Sx supports end character.
- Reading and writing word quantity limitation
  - A. Limited by the RAM capacity of PLC, the reading and writing word quantity should be less than 50.
  - B. Can not read part of the data. For example, define the data type to be “W, DW, S8”, if the reading word quantity is 10 and read from the first column W, the S8 will not be read completely, ID1000 will return error value. When the program found that the parameters were wrong, it will not read and write the SD card.
  - C. When reading or writing data, if one row is over, it will jump to the first column of the next row.
  - D. “.csv” file can not have space between data. When writing data into SD card, the address must be continuous, if not the ID1000 will have error code 20.
  - E. When reading the data, the address can not over the last data address, if not the ID1000 will produce error code.
- Default operation file

To save the time, after installing the SD card, it will read the data001.csv file, if there is no this file in the SD card, ID1000 will return code 2. But this will not affect the following operation for data001.csv file.

### 4. SD card state information ID1000

The SD card state information will show in ID1000. Especially when SD card has error, it can check the error code in ID1000 to find the solution.

ID1000	Meaning	Reasons
0	Successful	
1	Initialization failure	SD card is not installed well or is damaged
2	Reading or writing file does not exist	The operation file does not exist
3	Reserved	
4	Reserved	
5	Reserved	
6	Reserved	
7	Reserved	
8	Reading or writing error	Uninstall the SD card when reading or writing

9	Reserved	
10	Reserved	
11	FAT16 error	SD card has not been formatted to FAT16
12	Reserved	
13	Reserved	
14	Reserved	
15	Reserved	
16	Reserved	
17	Reserved	
18	Reserved	
19	SD card is not inserted	SD card is not inserted
20	Reading or writing parameter error	Please check the file index number, column, row and word number
21	The reading or writing data are not fit for format definition	There are illegal characters when data type is character
22	The file data type is wrong	There are data type definition exclusive of “w, dw, Sx, Fm.n”
23	Data type is not matching when reading the file	There are illegal characters when data type is character
24	Illegal file name	Index number >999
25	Illegal column index	Column index > file column numbers
26	Illegal row index	Row index number is 0 or 1
27	Illegal reading and writing word numbers	Word numbers >50

### 5. The type definition in “.csv” file

Before writing data into .csv file, you need to define the data type in the Excel table.

- A. Build a new Excel file, define the data type in the first row.

	A	B	C	D	E
1	w	dw	f3.2	s5	dw
2					
3					

- B. Save the file and named as dataxxx.csv. For example, data003.csv.

- C. After saving the file, open it in txt file, you will see the following things: each data type is divided by “,” automatically. In that way PLC can recognize it easily.

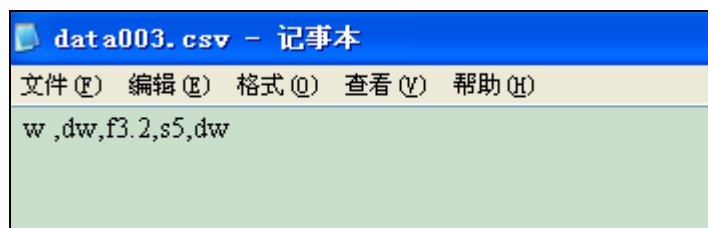

### 6. Install and set the BD board

### 1) Install the BD board

Open the PLC cover on the right, insert the BD board with the pins then fix it with screw, then put the cover back.

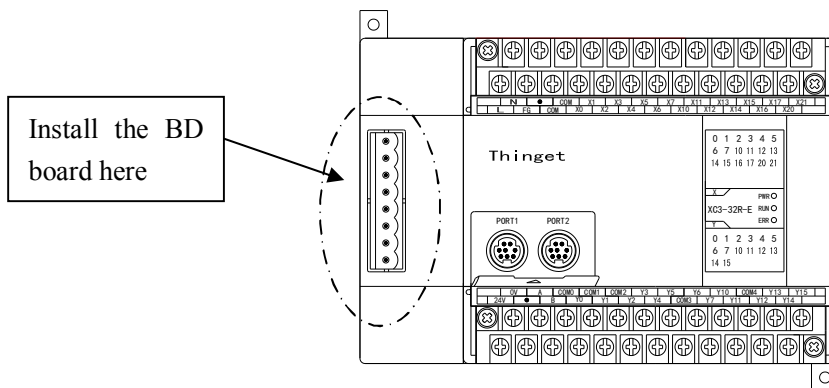

### 2) Install SD card

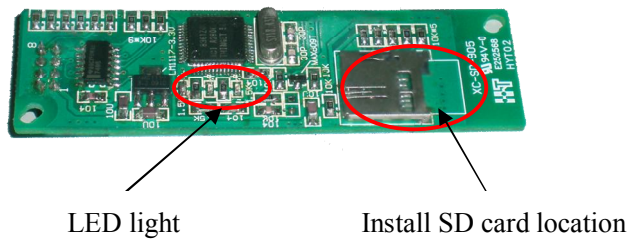

There are three LED lights on the XC-SD-BD, they are Power, Run and Error.

Power: always ON after power on;

Run: blinking when PLC and BD communication is normal

Always ON when PLC and BD communication is abnormal

Error: Off when there is no error

Always ON when there is no SD card, SD card broken or SD card is not formatted.

Blinking when there are other errors.

### 3) Set the BD board

Open XCPpro V3.2, click "configure/BD setting, then select other BD/BD SD, then click OK.

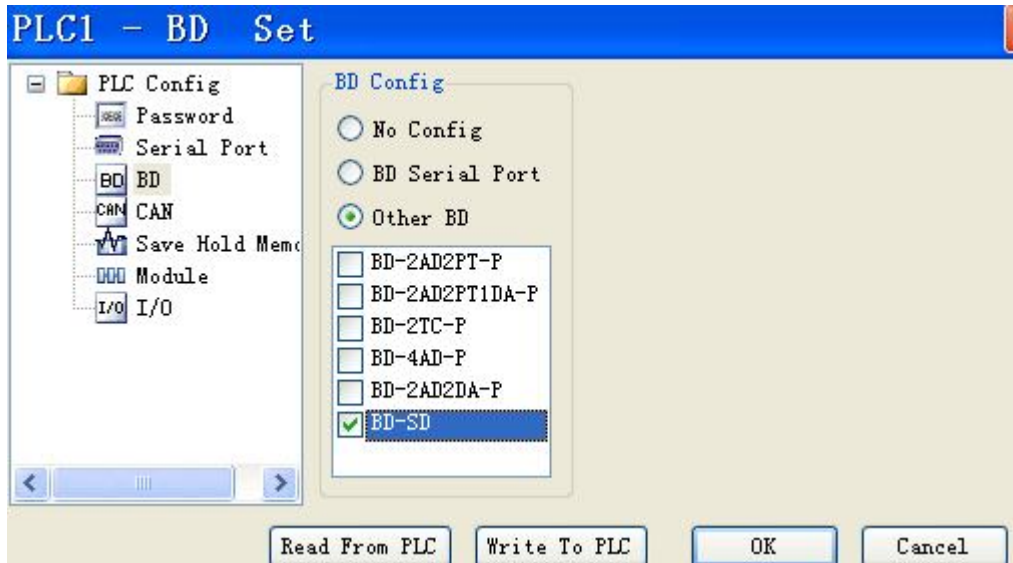

## 7. Format changing tool

When there are data in the Excel, please use format changing tool to transform the Excel format to .csv. The tool will be attached with this manual. Please see the operation steps:

Open Excel, click Tool/Add-Ins/Browse..., then select the format changing tool, click ok.

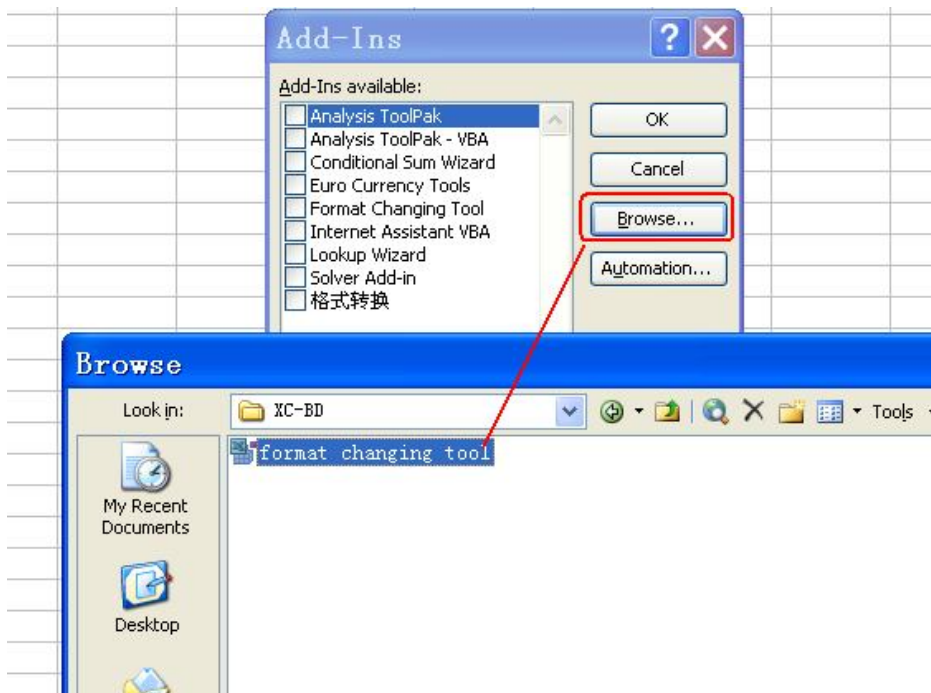



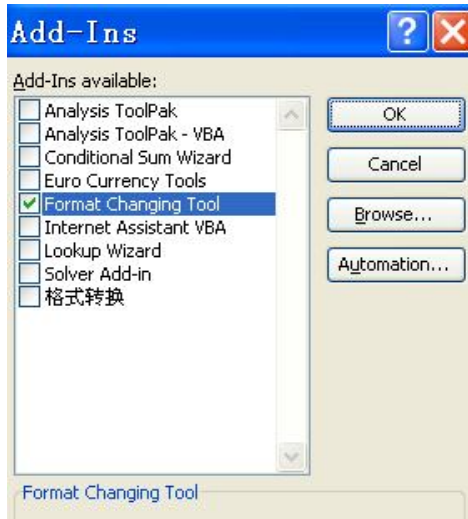

- A. In the tool menu, there is a format changing tool item. That means the tool installation is finished.
- B. When finished the data inputting, click “format changing tool”.
- C. At last, save the file as .csv format.

	A	B	C	D	E	F	G	H
1	w	dw	s8	f4.15	dw	w	dw	
2	2980	1786	HFASDF		-13212	-330	780240	
3	2471	-1912	JKSAHI		-25152	-23782	-665320	
4	9628	399	jak		4589	-7728	-884013	
5	9045	-2511			-4175	39600	195264	
6	1824	1413	f		26448	-1836	558904	
7	22300	701			-5835	-6534	1095926	
8	-1742	2719	f		-12382	-25761	-125260	
9	1636	2075	JSKI		2939	2400	345495	
10	9962	371	HDJM		5389	24660	827472	

## 8. Example

Write data in data001.csv in SD card, read data from data002.csv.

Process: format the SD card→build a csv file→make the program→install SD card and BD board→configure the BD board, download the program and the data→debug the program, monitor the running result

Step:

1. Transform the SD card format to FAT16 by card reader

- (1) Use card reader to connect SD card with PC. (SD card capacity should be less than 2GB).
- (2) Right click the SD card disk, choose format.
- (3) File system please select FAT.
- (4) Click start to format the SD card.

2. Build an empty file “data001.csv” and a file “data002.csv” with data in the root directory of SD card.

- (1) Open the SD card, build two new Excel files.
- (2) Open one of the file, input the following data types:

1	w	dw	f5.3	s7	w
2					

(3) Save the file as “data001.csv”. Then open it in txt, make sure it is correct.

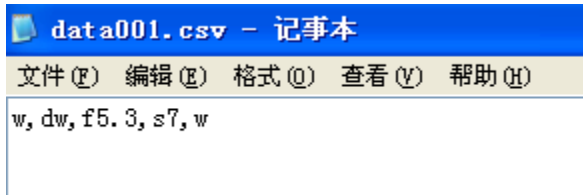

(4) Open another Excel file, input the data type in the first line, and input data in each row, the data in each row should be accord with the data type.

	A	B	C	D
1	w	s8	dw	f6.2
2	245	hfiw	1234567890	543631.32
3	415	sdlgjeoa	-534007321	464.1
4	14456	8gskhd	77182	7654.65
5	26654	nd903jlp	8945	3563
6	12356	48djlj=j	9054873	-13251.98
7	97	ey67	326483894	-645.8
8	-27658	e21	89490	15.54
9	4579	k*nlw	737328923	3165.3
10				

(5) Transform the data via format changing tool.

	A	B	C	D
1	w	s8	dw	f6.2
2	245	hfiw	1234567890	543631.32
3	415	sdlgjeoa	-534007321	464.1
4	14456	8gskhd	77182	7654.65
5	26654	nd903jlp	8945	3563
6	12356	48djlj=j	9054873	-13251.98
7	97	ey67	326483894	-645.8
8	-27658	e21	89490	15.54
9	4579	k*nlw	737328923	3165.3

(6) Save as “data002.csv”. Then open it in txt file:

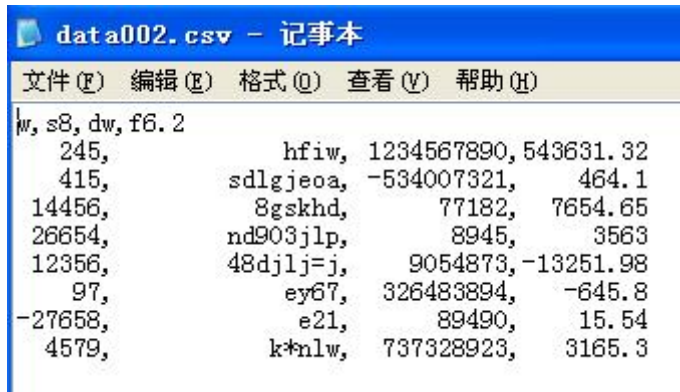

Before

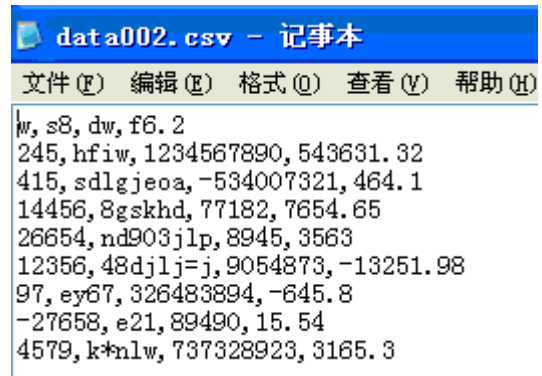

After

**Attention:** after format changing, if the data length is not enough, it will add space from the left side of the numbers. Before format changing, the data are out of order.

(7) File “data001” and “data002” setting are finished. Please delete the disk and pull out the SD card from the PC.

3. Make program in XCPpro software.

(1) Purpose:

A. write 16 words from D200 to row 1, line 2 of data001.csv.

B. read 25 words from row 2, line 3 of data002.csv to D400.

(2) Process:

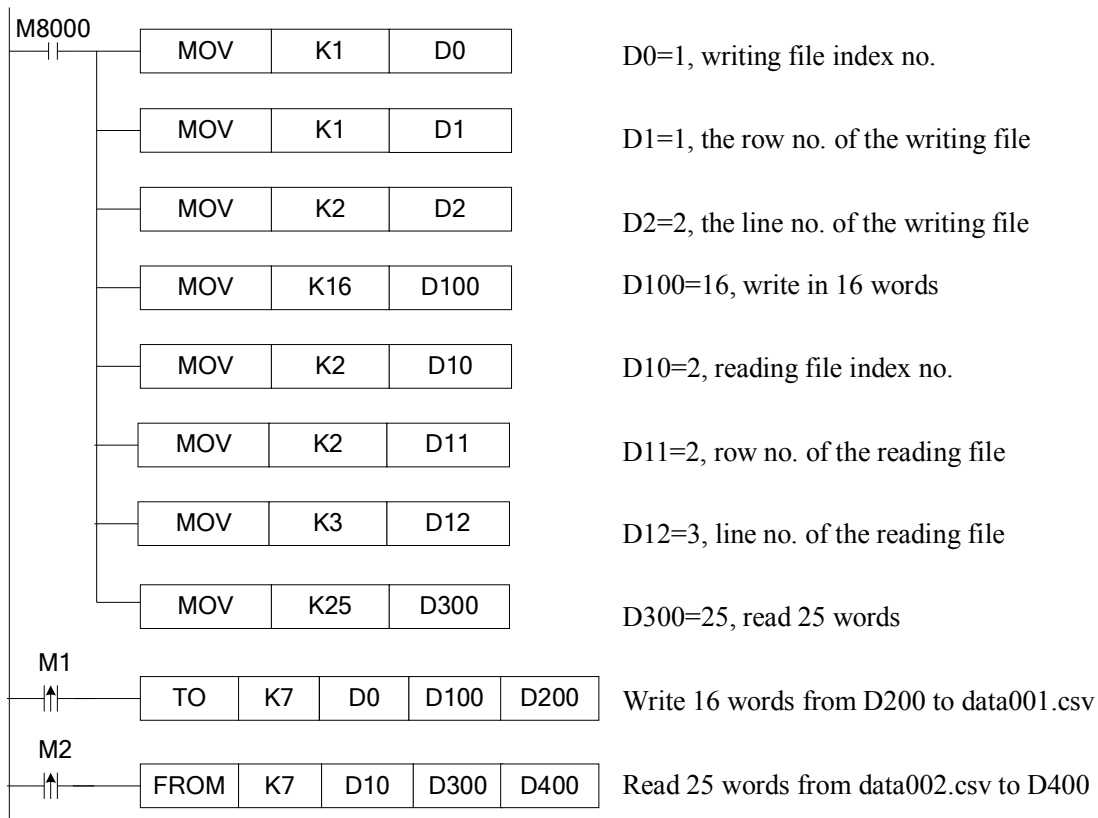

4. Insert the SD card on the XC-SD-BD, install the BD on the PLC.

(1) Power on the PLC, check the LED situation. POWER LED is ON, communication LED is flickering, ERROR LED is OFF.

(2) Connect the PLC with PC to configure the BD board.

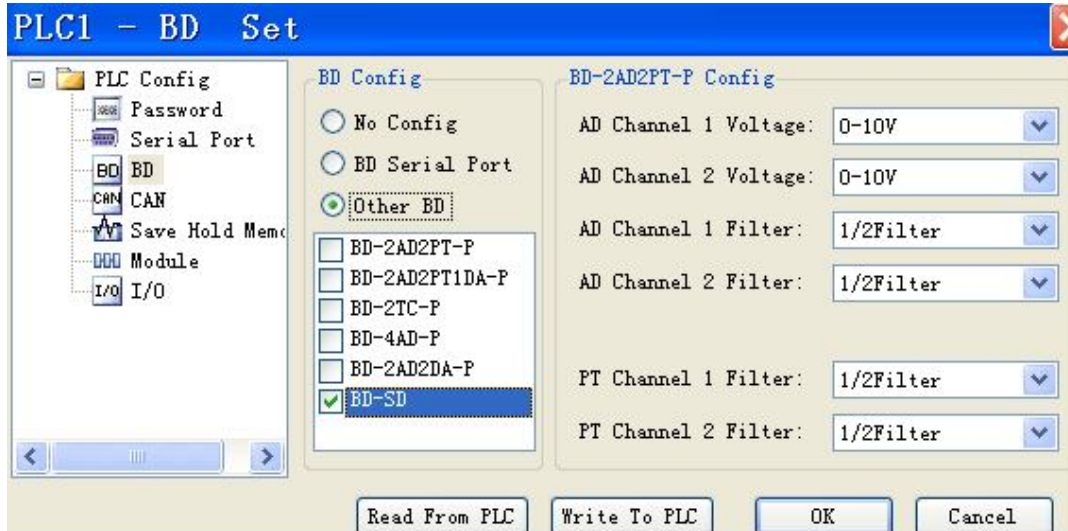

(3) Click “Online --- download program & data”, select “BD config” in the window:

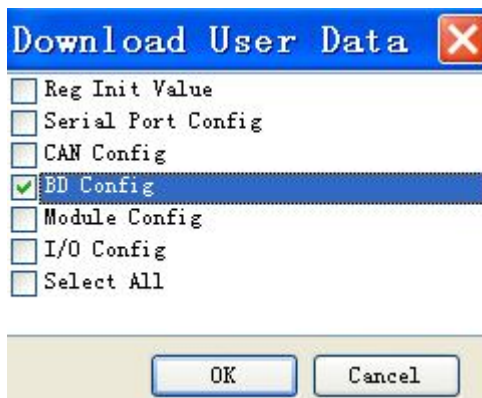

(4) Click the BD details in the project bar; you can see the BD board information.

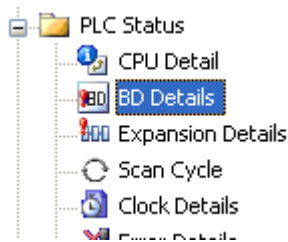

5. Run the program to see the result.

A. Write data into data001.csv

a) The data in D200~D215 of PLC are shown as the following:

Reg	Monitor value	Word length	Num Format
D200	12335	Word	Dec
D201	555881125	DWord	Dec
D203	78545.23	Float	Dec
D205	gh	Word	ASCII
D206	45	Word	ASCII
D207	9j	Word	ASCII
D208	3#	Word	ASCII
D209	+<	Word	ASCII
D210	5v	Word	ASCII
D211	?&	Word	ASCII
D212	-6786	Word	Dec
D213	-23412	Word	Dec
D214	-474327809	DWord	Dec

b) When M1 is from OFF→ON, write the data from D200~D215 to data001.csv.

The result of data001.csv is as the following:

```
w, dw, f5. 3, s7, w
12335, 555881125, 78545. 227, gh459j3#+<5v?&, -6786
-23412, -474327809,
```

B. Read data002.csv

a) The data will be read in data002.csv:

```
w, s8, dw, f6. 2
245, hfiw, 1234567890, 543631. 32
415, sdlgieoa, -534007321, 464. 1
14456, 8gskhd, 77182, 7654. 65
26654, nd903jlp, 8945, 3563
12356, 48djlj=j, 9054873, -13251. 98
97, ey67, 326483894, -645. 8
-27658, e21, 89490, 15. 54
4579, k*nlw, 737328923, 3165. 3
```

b) when M2 is from OFF→ON, read the data from data002.csv to D400~D424 of PLC:

D400		Word	ASCII
D401		Word	ASCII
D402		Word	ASCII
D403		Word	ASCII
D404	sd	Word	ASCII
D405	lg	Word	ASCII
D406	je	Word	ASCII
D407	oa	Word	ASCII
D408	-534007321	DWord	Dec
D410	464.1	Float	Dec
D412	14456	Word	Dec
D413		Word	ASCII
D414		Word	ASCII
D415		Word	ASCII
D416		Word	ASCII
D417		Word	ASCII
D418	8g	Word	ASCII
D419	sk	Word	ASCII
D420	hd	Word	ASCII
D421	77182	DWord	Dec
D423	7654.65	Float	Dec

C. the process of reading the data from SD card to PLC registers:

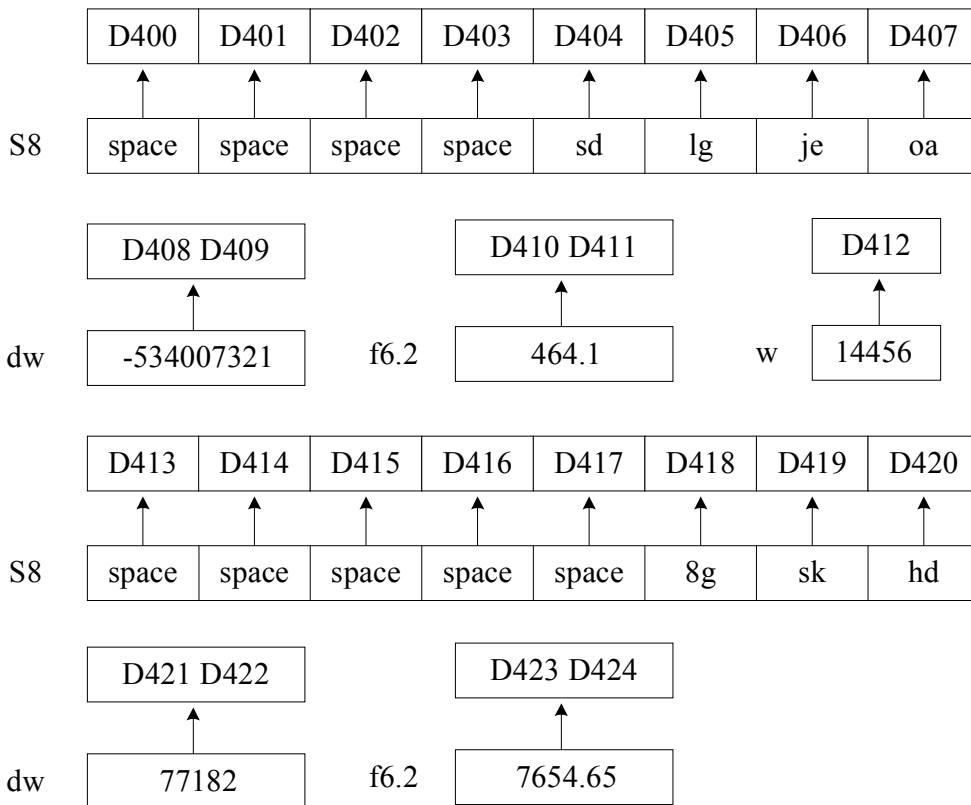

---

## 6. Ethernet expansion board XC-TBOX-BD

### 1. Summarization

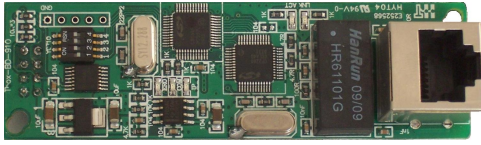

- Ethernet BD board is used to access to Ethernet, special for XC series PLC
- Support Modbus-RTU protocol
- Suitable for remote monitoring, upload/download, etc
- XCPpro software version 3.0f and above

### 2. Characteristics

- Flexible distributed automation structure, simplify the system management
- Standard RJ45 interface, TCP/IP protocol
- To realize remote monitoring, checking and programming, save time and cost
- To store and deal with the data via Ethernet, simplify the data processing and filing
- Connect PLC with Ethernet to realize intercommunication with other devices
- High cost performance, easy to maintain, support simple user's friendly diagnose function

### 3. System construction

The industrial Ethernet system contains XC-TBOX-BD, PC, XC series PLC, XCPpro software, HMI, switch, twisted-pair cable, etc.

### 4. Suitable field

Industrial Ethernet is an electrical network which based on shielded coaxial cable, twisted-pair cable or optical fiber which based on optical network. It is accord with IEEE802.3 by using ISO and TCP/IP protocol. As the expansion of Modbus/RTU protocol, Modbus/TCP protocol defines the standard of TCP/IP network transmission and application. XC-TBOX-BD meets the requirements for industrial network automation control. It provides complete solution and reliable control method.

The application based on XC-TBOX-BD:

- Remote monitor, maintain and debug the PLC program of the IP device
- Traditional Modbus communication is one-master-multi-slaver mode, the speed is very slow. By using XC-TBOX-BD, master station can communicate with other branch stations.

In the following picture, XC-TBOX-BD and TBOX support devices with Modbus/RTU interface connecting to Ethernet. It can realize multi-master-multi-slaver system; make the devices suitable for complicated system.



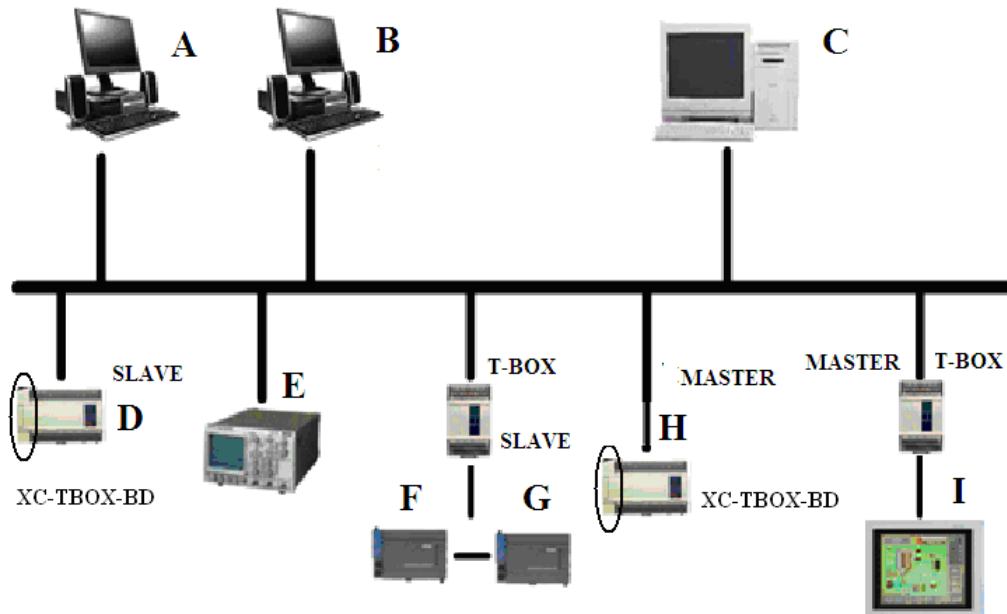

### 5. Interface for Ethernet

- Ethernet interface is RJ45, please see the photo on the right:
- The pin definition of RJ45:



Pin	Wire color	Signal	Direction
S1	Orange white	TXD+	Output
S2	Orange	TXD-	Output
S3	Green white	RXD+	Input
S4	Blue	-	-
S5	Blue white	-	-
S6	Green	RXD-	Input
S7	Brown white	-	-
S8	Brown	-	-

### 6. Install the BD board

Open the cover on the left of PLC, insert the board on the pins, fix it with the screw.

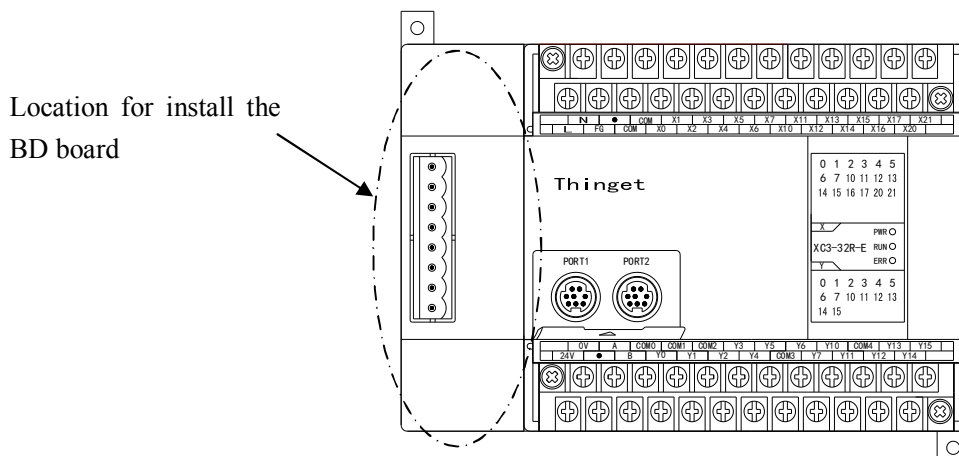



## 7. Configure the BD board

- Install the BD board on the PLC
- Connect PLC with PC, use XCPpro software to configure the BD board
- Select configure/BD setting, then click BD serial port:

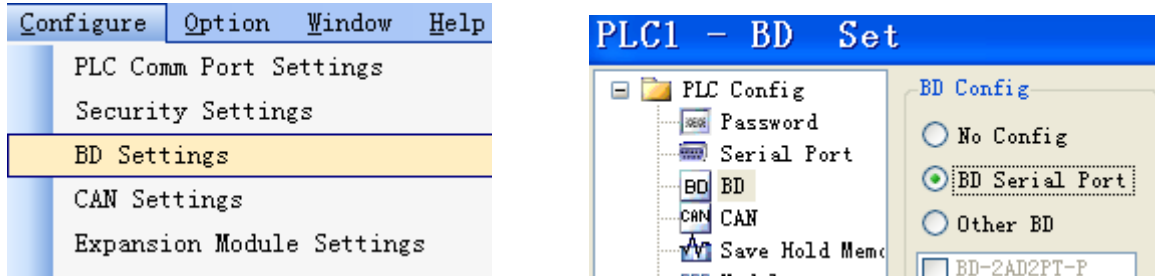

## 8. DIP switch

XC-TBOX-BD has four DIP switches:

ON

1	2	3	4
---	---	---	---

OFF

The function of DIP switch:

Switch	Status	Function
S1	ON	SLAVE mode
	OFF	MASTER mode
S2	ON	Close time log on
	OFF	Time log on status
S3	ON	IP address configuration
	OFF	Use static IP address ( 192.168.0.111 )
S4	ON	Close DHCP distribution
	OFF	Use DHCP distribution

- There are 3 modes to set the IP address: please select the mode via DIP switch

- Use static IP address
- Use DHCP distribution
- Set by users

- The priority of the 3 modes are A>B>C.

### A: use static IP address (S3 ON, S4 random)

When using the TBOX-BD at the first time, please use static IP address.

IP address: 192.168.0.111

Subnet mask: 255.255.255.0

Default gateway: 192.168.0.1

Preferred DNS: 192.168.0.1

### B: Use DHCP distribution (S3 ON, S4 OFF)

DHCP distribution is similar to the IP distribution in PC.

Note: there must be DHCP server in the net.

Suggestion: you'd better not use this mode when having condition

**C : use the address set by users ( S3 ON, S4 OFF )**

IP address, subnet mask, default gateway, preferred DNS (the same as default gateway)

### 9. LED display

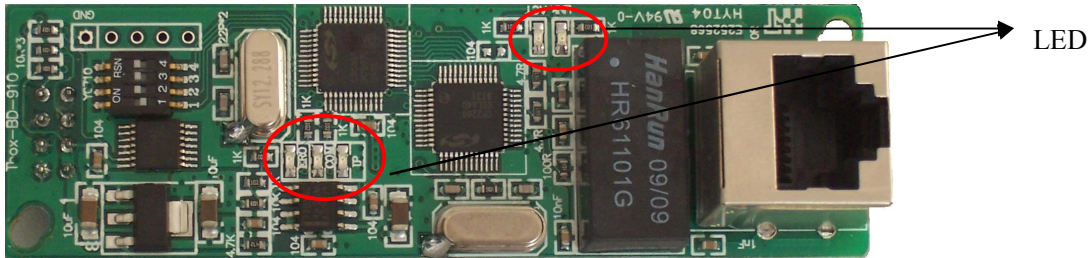

LED	Name	Function
ERO	Error checking	ON: CRC checking error for the data received from serial port(LED is OFF when the next data are correct)
COM	Serial port	Flicker: connected
IP	IP address	ON: IP address is conflicted
LINK	Ethernet link	ON: network connection is normal
ACT	Data receiving	Flicker: receiving the data

### 10. Using steps

If you want to connect the PLC in the Ethernet, you have to set the T-BOX-BD first. Please see the steps:

#### (1) Hardware connection and setting

- A Install the XC-TBOX-BD on the PLC.
- B Make sure the XCPpro version is v3.0f.
- C Set the DIP switch according to the requirements.
- D Make sure XC-TBOX-BD is connected with Ethernet. Electrify the PLC.

Note: when using XC-TBOX-BD at the first time, please set DIP switch S3 to OFF, make it as static IP (192.168.0.111), then connect with Ethernet to set parameters.

- E Make sure PC with XCPpro software are in the network.

#### (2) Set the parameters

- A. Open XCPpro software, double click “communication: COM”

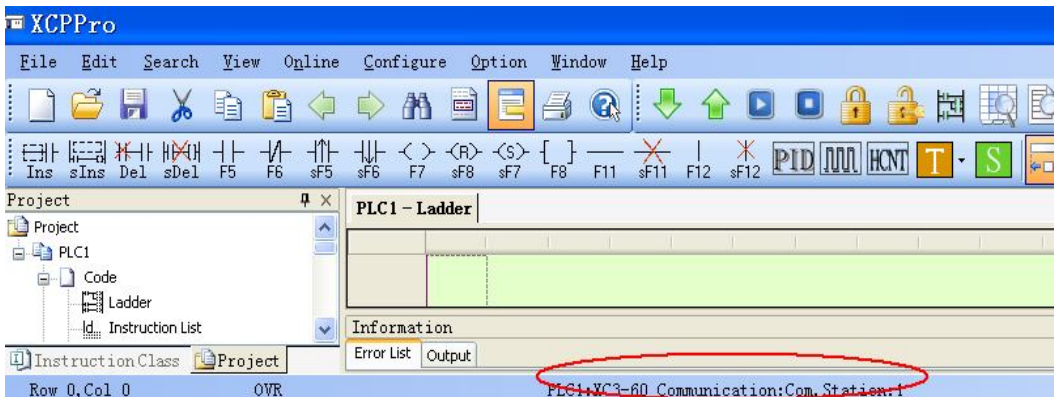

B. Click “+” in the select communication mode window

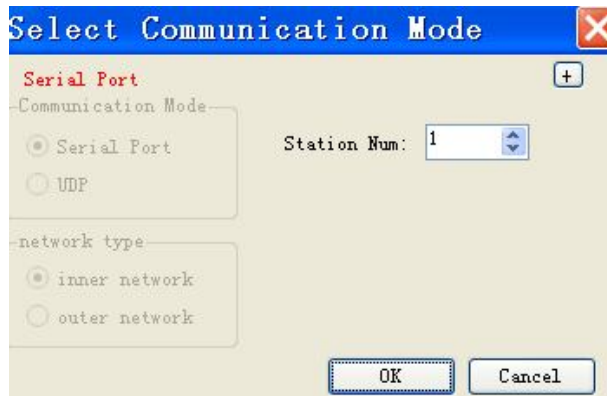

C. Click “refresh list” to search the XC-TBOX-BD in the network. There are two conditions to edit the XC-TBOX-BD.

(1) Use XC-TBOX-BD at the first time, S3 is OFF, static IP address; the rest parameters are shown as below:

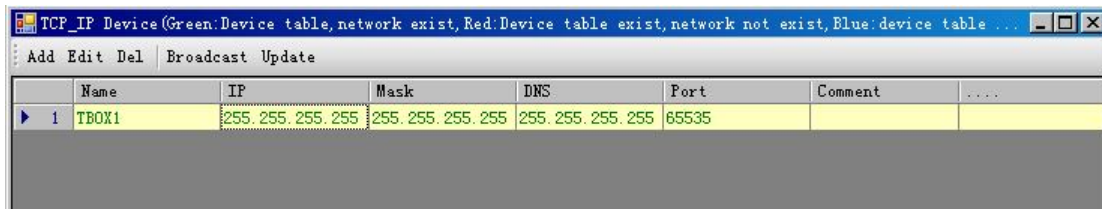

	Name	IP	Mask	DNS	Port	Comment	.....
▶ 1	TBOX1	255.255.255.255	255.255.255.255	255.255.255.255	65535		

(2) If there is IP address in the XC-TBOX-BD, S3 is ON, the parameters are shown as below:

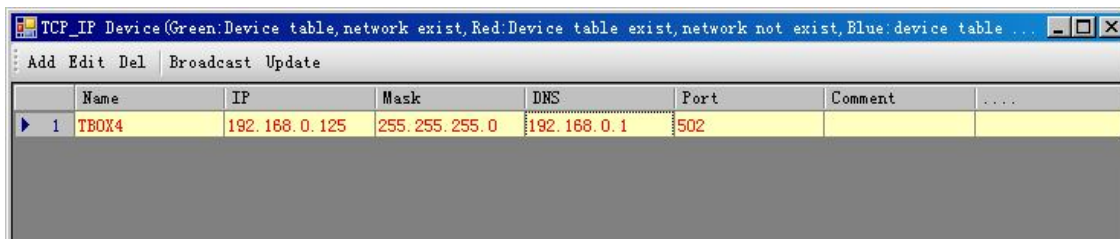

	Name	IP	Mask	DNS	Port	Comment	.....
▶ 1	TBOX4	192.168.0.125	255.255.255.0	192.168.0.1	502		

D. Double click the TBOX in the device list, you can see the parameters of TBOX1 and TBOX4:

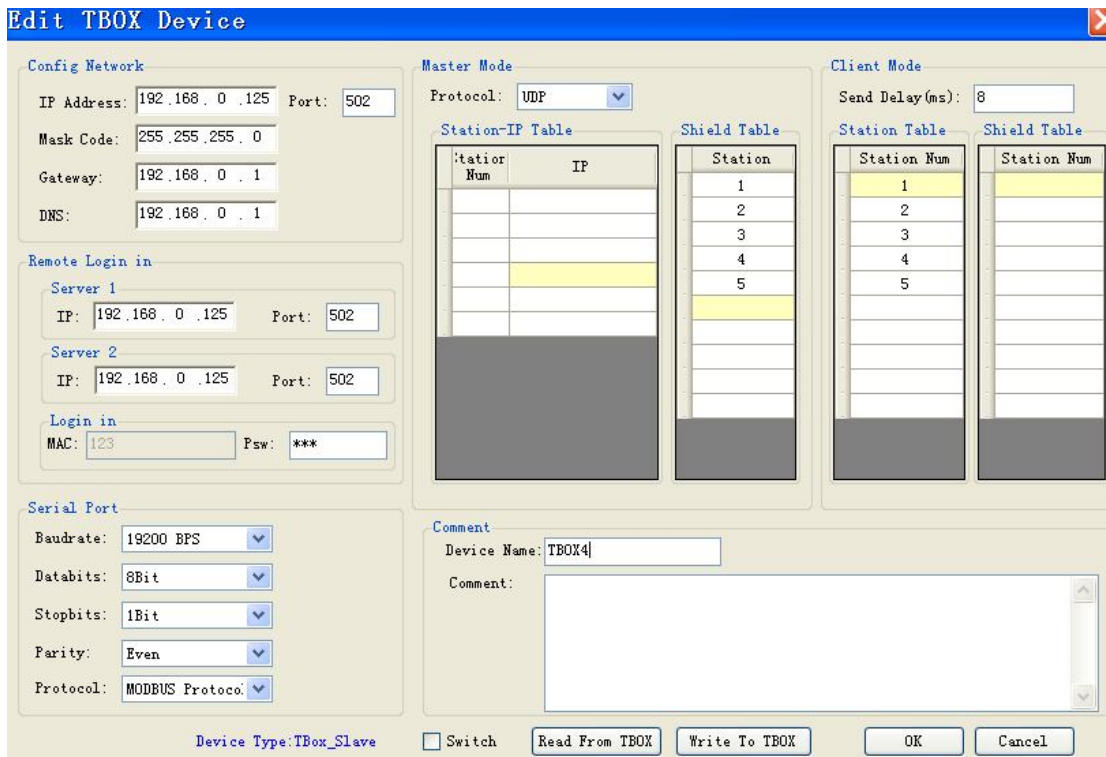
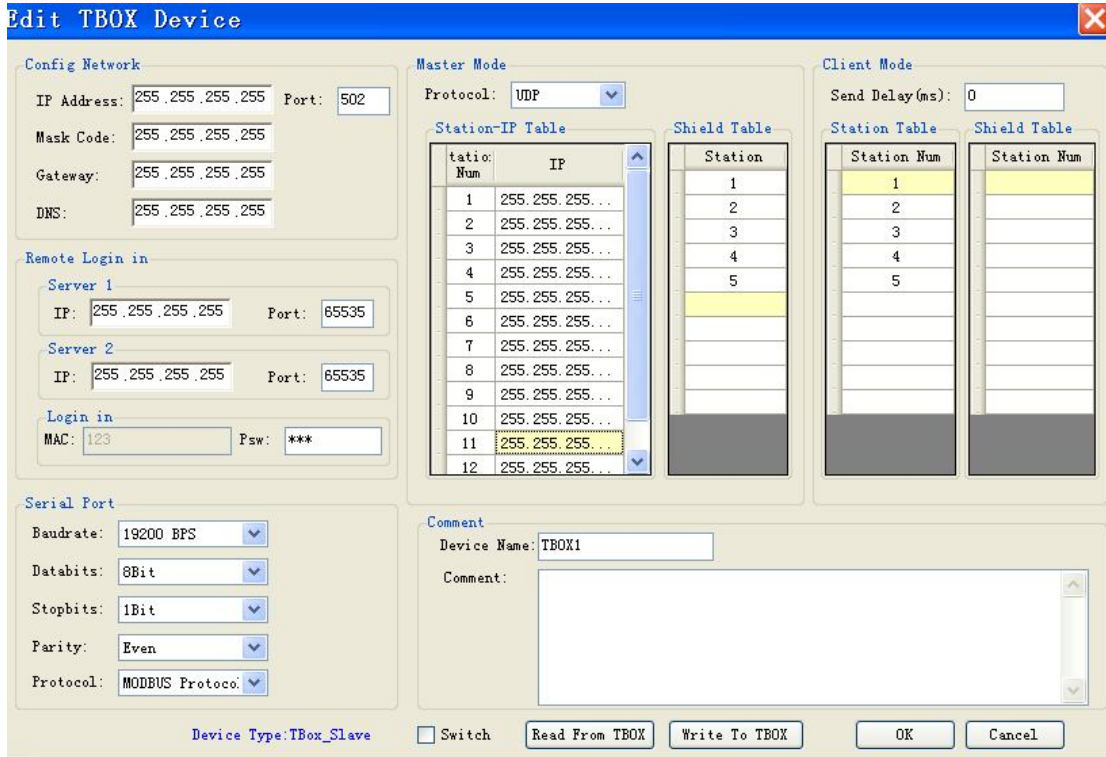

### Explanation for the parameters:

- **Configure network**

When DIP switch S3 is off, user can set relevant parameters in IP device according to actual using, including IP address、 subnet mask、 default gateway、 preferred DNS(usually the same as default gateway).After settings are finished, set ON the DIP switch S3 to identify other XC-TBOX-BD with static IP in the network.

---

- **Remote login in (still developing)**

The aim of setting this part of parameters is to connect the XC-TBOX-BD and its device into the WAN, user can maintain the remote devices via the remote login in function.

- ◆ Server 1 and 2: the IP address and port part can be modified according to actually using environment, then click “write in XC-TBOX-BD”
- ◆ Login part: MAC and password can be used as the user name and password when XC-TBOX-BD is remote landing, also can be set according to user’s demand(only one combination is the best to prevent from conflicting in the server list)

Additionally, when DIP switch S2 is OFF, XC-TBOX-BD is remote timing landing mode which can save the bandwidth of network and T-BOX.

- **Serial parameters**

It includes five parts: baud rate、 data bit、 stop bit and protocol type. Baud rate can be modified but its numerical value must be consistent with that of connecting device.

- **Master mode and client mode**

Under the “edit IP device” dialog box, it will show device type. When XC-TBOX-BD is master mode, it shows “device type: T-BOX\_Master”, the parameters setting of “Master” part is effective, “Slave” part is ineffective. When XC-TBOX-BD is slave mode, it shows “device type: T-BOX\_Slave”, the parameters setting of “Slave” part is effective and that of “Master” part is ineffective.

- ◆ **Device type: XC-TBOX-BD Master**

It includes three sections: protocol, station number- IP table and shield table.

- Protocol: UDP: more efficient and faster  
TCP: better stability to send and receive data, but occupy more resources
- Station number-IP table: station number: in Industrial Ethernet, the station number of Slave station  
IP address: slave station IP address
- Shield table: for application, when XC-TBOX-BD is Master mode, it can connect with several Modbus devices with different station numbers by RS485 communication, but only one can be Modbus Master device and others are Modbus Slave devices. Then, list the station numbers of Modbus Slave devices in shield table in order to limit their access authority for XC-TBOX-BD.

- ◆ **Device type: XC-TBOX-BD Slave**

It includes three sections: send delay (ms), static station number table and shield table.

- Send delay: as soon as XC-TBOX-BD receives the reply from Slave device, it will send next order at once. Adding delay time between reply and sending order to reduce the possibility of lose command packets of the slave device.
- Static station number table: the station number of Slave device in Industrial Ethernet, supporting direct access
- Shield table: in Industrial Ethernet, when Master device access to Slave device by broadcasting mode, in order to limit the access authority of this slave station, write the IP of this slave station into the shield table.

- **Comment**

It contains device name and comment. User can modify them and click OK to confirm.

E. Click “Write into T-BOX”, then click “OK”. The devices will be listed in the TCP-IP device window. Close this window.

F. It shows “select communication mode” window, please select “UDP” for communication mode, network type can be “outer network” or “inner network”. If there are many XC-TBOX-BD, only the target station works. Now, you can monitor and upload, download program of PLC via Ethernet.

G Click “OK” to finish the XC-TBOX-BD parameters setting.

## 11. Example

The following is a Ethernet consisted of three PLC and one HMI.

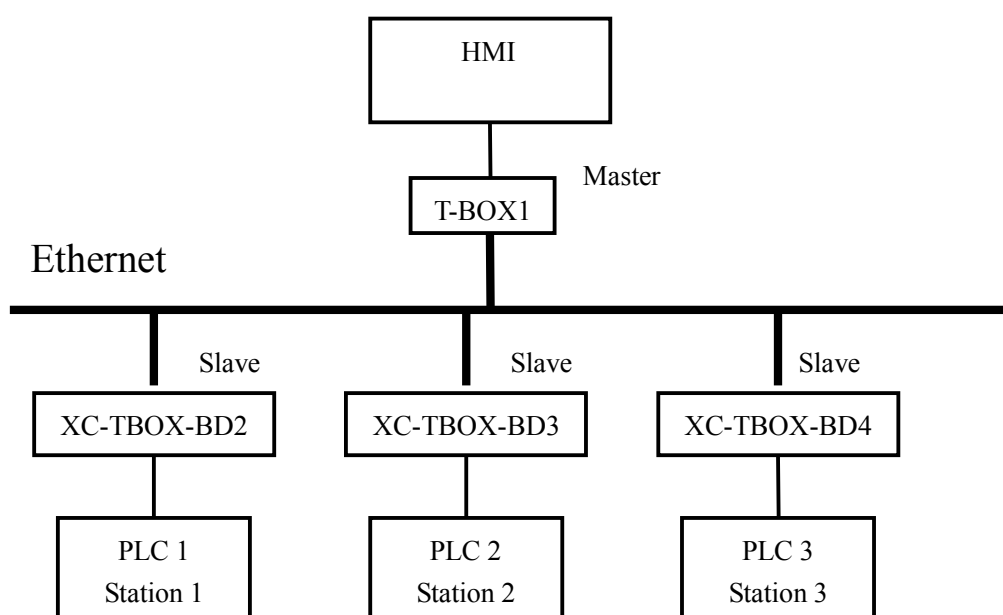

In this system, there are 3 XC-TBOX-BD and 1 T-BOX. T-BOX is master mode, others are slave mode. HMI is master device, PLC1, PLC2, PLC3 are slave devices.

This system's purpose is to control multi slave devices by multi master devices. Make the industrial network being used widely.

The steps are as shown as below:

- 1) Confirm the station number of the 3 PLC via XCPpro software.
- 2) Connect TBOX1 and XC-TBOX-BD with related devices. If use TBOX1 and XC-TBOX-BD at the first time, set S3 switch to OFF (static IP address), connect the TBOX1 and XC-TBOX-BD with the Ethernet, configure them with XCPpro software. After finishing the setting for one TBOX, turn on S3 and continue setting next XC-TBOX-BD.

(3) Configure the XC-TBOX-BD. Select the BD serial port.

(4) Set the IP address:

T-BOX1: 192.168.0.1

XC-TBOX-BD2: 192.168.0.2

XC-TBOX-BD3: 192.168.0.3



XC-TBOX-BD4: 192.168.0.4

Please see the edit TBOX device window:

T-BOX1 parameters setting:

**Edit TBOX Device**

**Config Network**  
IP Address: 192.168.0.1 Port: 502  
Mask Code: 255.255.255.0  
Gateway: 192.168.0.1  
DNS: 192.168.0.1

**Remote Login in**  
Server 1  
IP: 192.168.0.40 Port: 502  
Server 2  
IP: 192.168.0.40 Port: 502  
Login in  
MAC: 123 Psw: \*\*\*

**Serial Port**  
Baudrate: 19200 BPS  
Databits: 8Bit  
Stopbits: 1Bit  
Parity: Even  
Protocol: MODBUS Protocol

**Master Mode**  
Protocol: UDP  
**Station-IP Table**  

Station Num	IP
1	192.168.0.2
2	192.168.0.3
3	192.168.0.4

**Shield Table**  

Station
---------

**Client Mode**  
Send Delay (ms): 3  
**Station Table**  

Station Num
-------------

**Shield Table**  

Station Num
-------------

**Comment**  
Device Name: TBOX1  
Comment: Defaulted TBOX, Need Edit, Create Date of: 2009-12-14 12:56:12

Device Type: TBox\_Slave  Switch  Read From TBOX Write To TBOX OK Cancel

XC-TBOX-BD 2 parameters setting:

**Edit TBOX Device**

**Config Network**  
IP Address: 192.168.0.2 Port: 502  
Mask Code: 255.255.255.0  
Gateway: 192.168.0.1  
DNS: 192.168.0.1

**Remote Login in**  
Server 1  
IP: 255.255.255.255 Port: 65535  
Server 2  
IP: 255.255.255.255 Port: 65535  
Login in  
MAC: 123 Psw: \*\*\*

**Serial Port**  
Baudrate: 19200 BPS  
Databits: 8Bit  
Stopbits: 1Bit  
Parity: Even  
Protocol: MODBUS Protocol

**Master Mode**  
Protocol: UDP  
**Station-IP Table**  

Station Num	IP
-------------	----

**Shield Table**  

Station
---------

**Client Mode**  
Send Delay (ms): 3  
**Station Table**  

Station Num
-------------

**Shield Table**  

Station Num
-------------

**Comment**  
Device Name: TBOX2  
Comment:

Device Type: TBox\_Slave  Switch  Read From TBOX Write To TBOX OK Cancel

XC-TBOX-BD3 parameters setting:

**Edit TBOX Device**

**Config Network**  
 IP Address: 192.168.0.3 Port: 502  
 Mask Code: 255.255.255.0  
 Gateway: 192.168.0.1  
 DNS: 192.168.0.1

**Remote Login in**  
 Server 1  
 IP: 255.255.255.255 Port: 65535  
 Server 2  
 IP: 255.255.255.255 Port: 65535  
 Login in  
 MAC: 123 Psw: \*\*\*

**Serial Port**  
 Baudrate: 19200 BPS  
 Databits: 8Bit  
 Stopbits: 1Bit  
 Parity: Even  
 Protocol: MODBUS Protocol

**Master Mode**  
 Protocol: UDP

**Client Mode**  
 Send Delay(ms): 3

**Station-IP Table**

Station Num	IP

**Shield Table**

Station

**Station Table**

Station Num

**Shield Table**

Station Num

**Comment**  
 Device Name: TBOX3  
 Comment:

Device Type: TBox\_Slave  Switch

XC-TBOX-BD4 parameters setting:

**Edit TBOX Device**

**Config Network**  
 IP Address: 192.168.0.4 Port: 502  
 Mask Code: 255.255.255.0  
 Gateway: 192.168.0.1  
 DNS: 192.168.0.1

**Remote Login in**  
 Server 1  
 IP: 255.255.255.255 Port: 65535  
 Server 2  
 IP: 255.255.255.255 Port: 65535  
 Login in  
 MAC: 123 Psw: \*\*\*

**Serial Port**  
 Baudrate: 19200 BPS  
 Databits: 8Bit  
 Stopbits: 1Bit  
 Parity: Even  
 Protocol: MODBUS Protocol

**Master Mode**  
 Protocol: UDP

**Client Mode**  
 Send Delay(ms): 3

**Station-IP Table**

Station Num	IP

**Shield Table**

Station

**Station Table**

Station Num

**Shield Table**

Station Num

**Comment**  
 Device Name: TBOX4  
 Comment:

Device Type: TBox\_Slave  Switch

Then click write to TBOX. The following steps please refer to “Using step”. Now the TBOX parameters setting are finished.



## 7. Weighing expansion BD XC-WT-BD

### 1. Summarization

XC-WT-BD is the expansion BD board of XC series PLC. It can test the 0~39.0625mV voltage signal from pressure sensor, and transform the voltage to digital value.

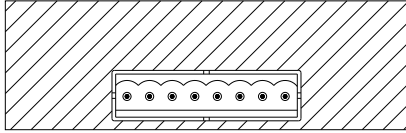

- Collect one channel pressure sensor signal
- Test voltage range is 0~39.0625mV
- 16-bit A/D transformation

### 2. Specifications

Analog input	DC 0~39.0625mV
Digital output	0~65535
Resolution	0.596uV
Transformation speed	20ms/channel
Working ambient	No corrosive gas
Ambient temperature	0°C~60°C
Storage temperature	-20~70°C
Ambient humidity	5~95%
Storage humidity	5~95%

### 3. Terminals

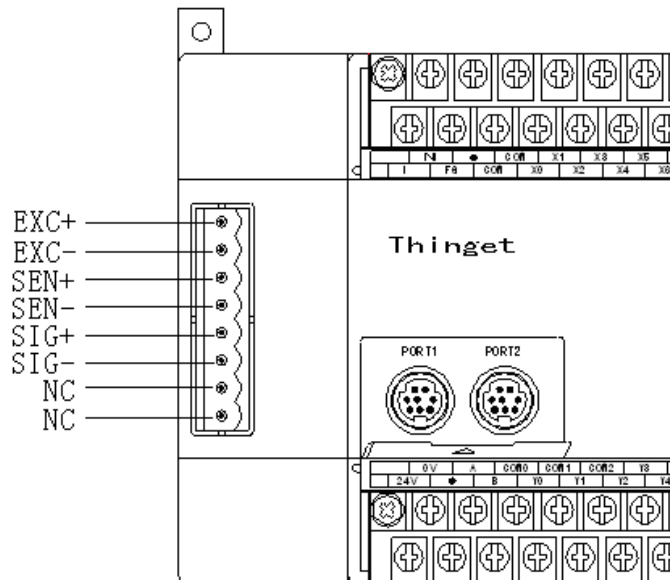

Terminal	Name	Meaning
EXC+	Weighing sensor power +	EXC+, EXC- connect to weighing sensor power terminal
EXC-	Weighing sensor power -	
SEN+	External reference input +	SEN+, SEN- connect to EXC+, EXC-
SEN-	External reference input -	

SIG+	Weighing sensor signal +	SIG+, SIG- connect to sensor signal output terminal
SIG-	Weighing sensor signal -	

Note: for real application, EXC+ connects to SEN+ and sensor power +, EXC- connects to SEN- and sensor power -. SIG+ connects to sensor output +, SIG- connects to sensor output -.

#### 4. Weighing system

A typical weighing system:

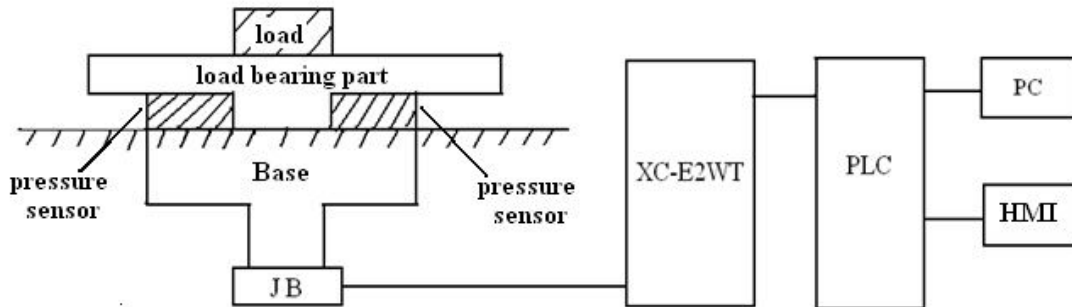

The weighing system contains:

**Loading bearing part:** to support the load. Such as flat, hopper, container, air transport car...

**Pressure sensor:** transform the weight to voltage signal.

**Assembly part:** make sure the pressure sensor can work correctly, assembly part and direct part can avoid overload. Overload will cause measurement error and sensor damage.

**Connection box (JB):** to collect several sensor signals.

**XC-WT-BD:** can be used as an electronic assessment device, it gets the pressure sensor signal and makes further assessment.

#### 5. Pressure sensor

The pressure sensor is based on resistance strain effect, see the following diagram:

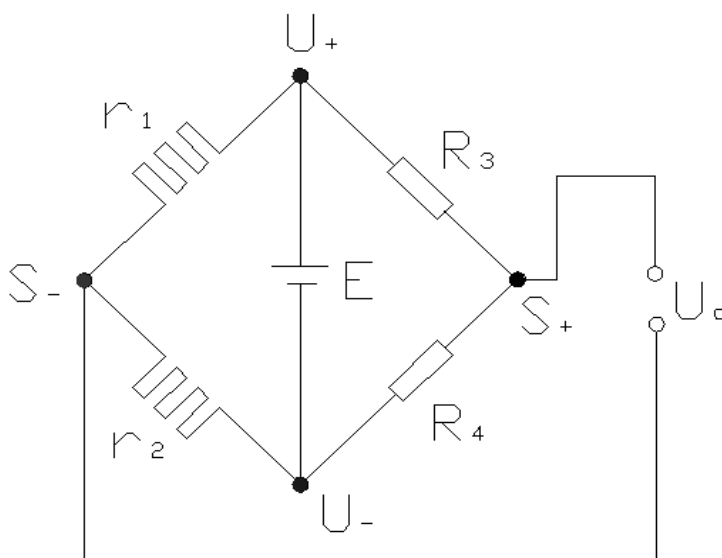

R1 and R2 is strain resistor which make bridge circuit with R3 and R4. With the change of R1 and R2, the bridge circuit will lose the balance, unbalance voltage  $U_o$  will be produced as the output of sensor.

---

U+ and U- are positive and negative point of the sensor power supply. Please select the 5V power of the module or from outside.

S+ and S- are positive and negative point of the sensor output. Connect the output to the module to test the weight.

### 6. A/D transformation diagram

The relationship between input voltage and converted digital value:

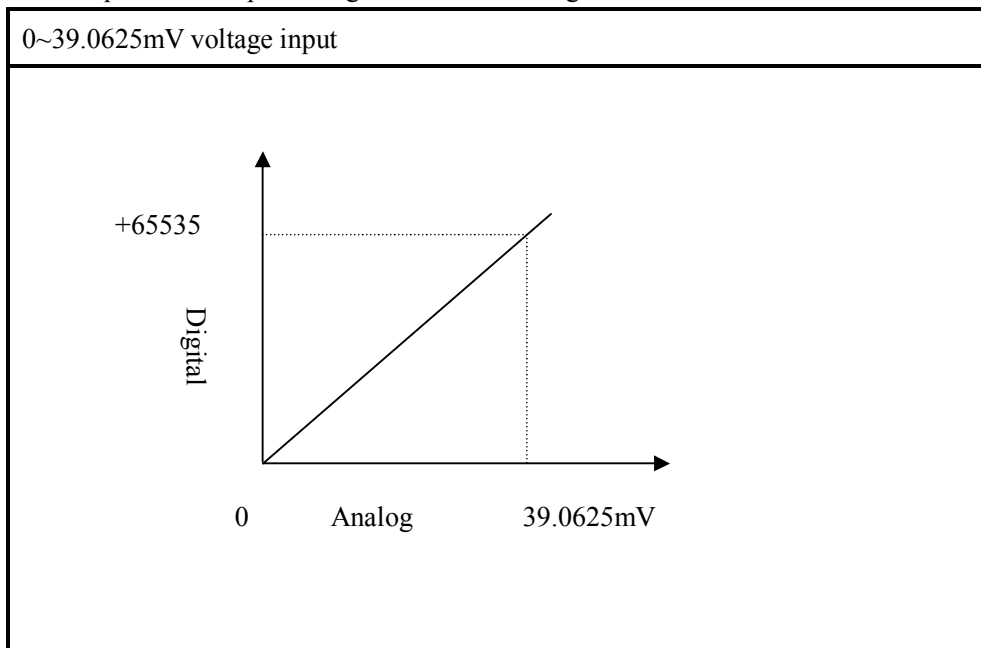

### 7. I/O address

XC-WT-BD will not occupy I/O address, the A/D transformed value will be stored in PLC register ID1000.

### 8. Programming example

Suppose the pressure sensor range is 0~100KG (the sensor output voltage range is 0~20.00mV). Display the weight (unit is kG) value in the HMI.

Program:

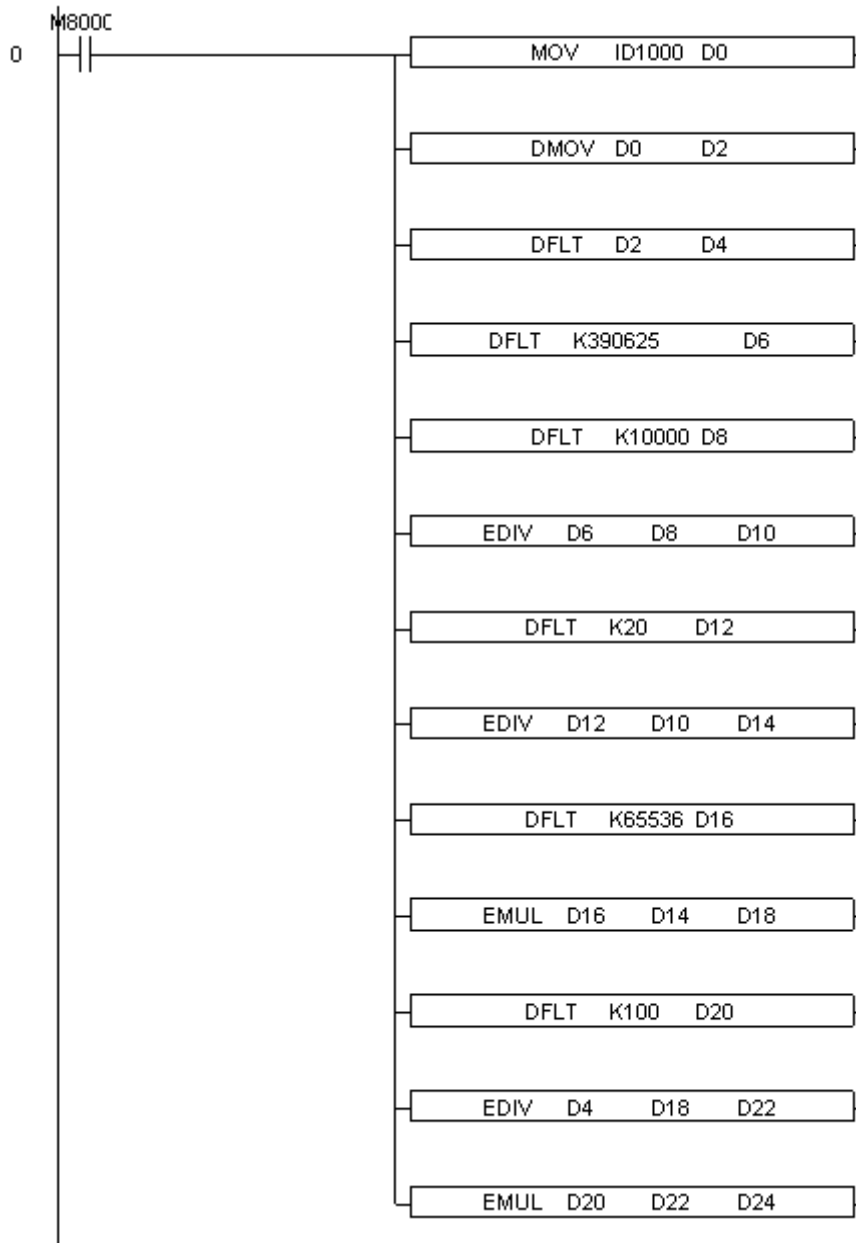

D4: real-time weight digital value (float number)

D10: the full-range analog value of XC-WT-BD (float number)

D14: (the full-range analog value of pressure sensor) ÷ (the full-range analog value of XC-WT-BD)

D18: the digital value range of XC-WT-BD (float number)

D22: (digital value) ÷ (weight) (float number)

D24: the real weight, unit is kG (float number)

## 8. Fiber Optical Communication expansion BD XC-OFC-BD

### 1. Summarization

XC-OFC-BD has high baud rate and fast communication speed. The signal is transferred through light wave. Light wave has strong noise immunity ability; the max transmission distance is 1KM. It is easy to build the network, the slave station can up to 254.

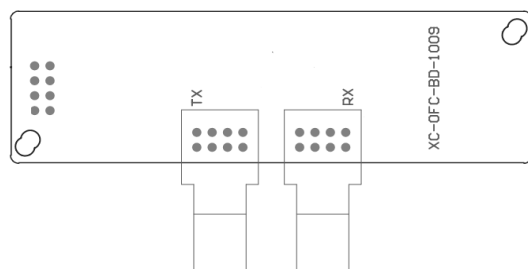

TX: send terminal  
RX: receive terminal

### 2. Installation and wiring

#### (1) Installation

Open the left cover of PLC, install the BD board into the pins, fix it with the screws, and close the cover.

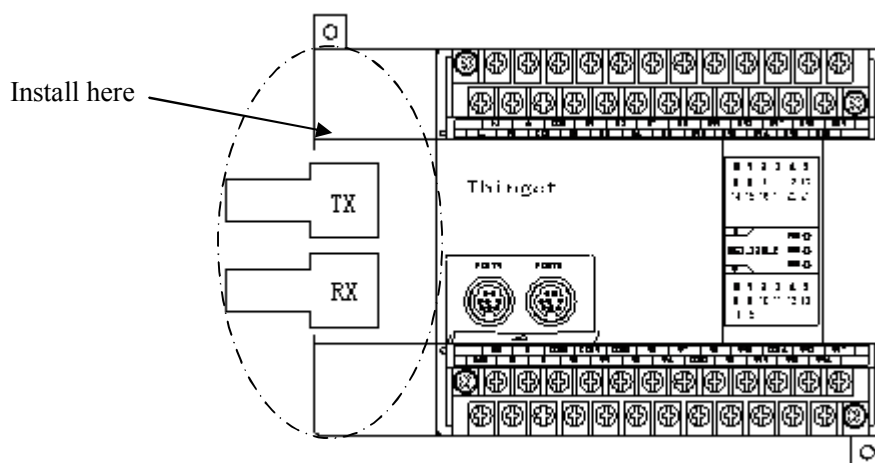

Please keep clean for the fiber optical terminal. Please put on the protection cover to prevent pollution.

#### (2) Wiring

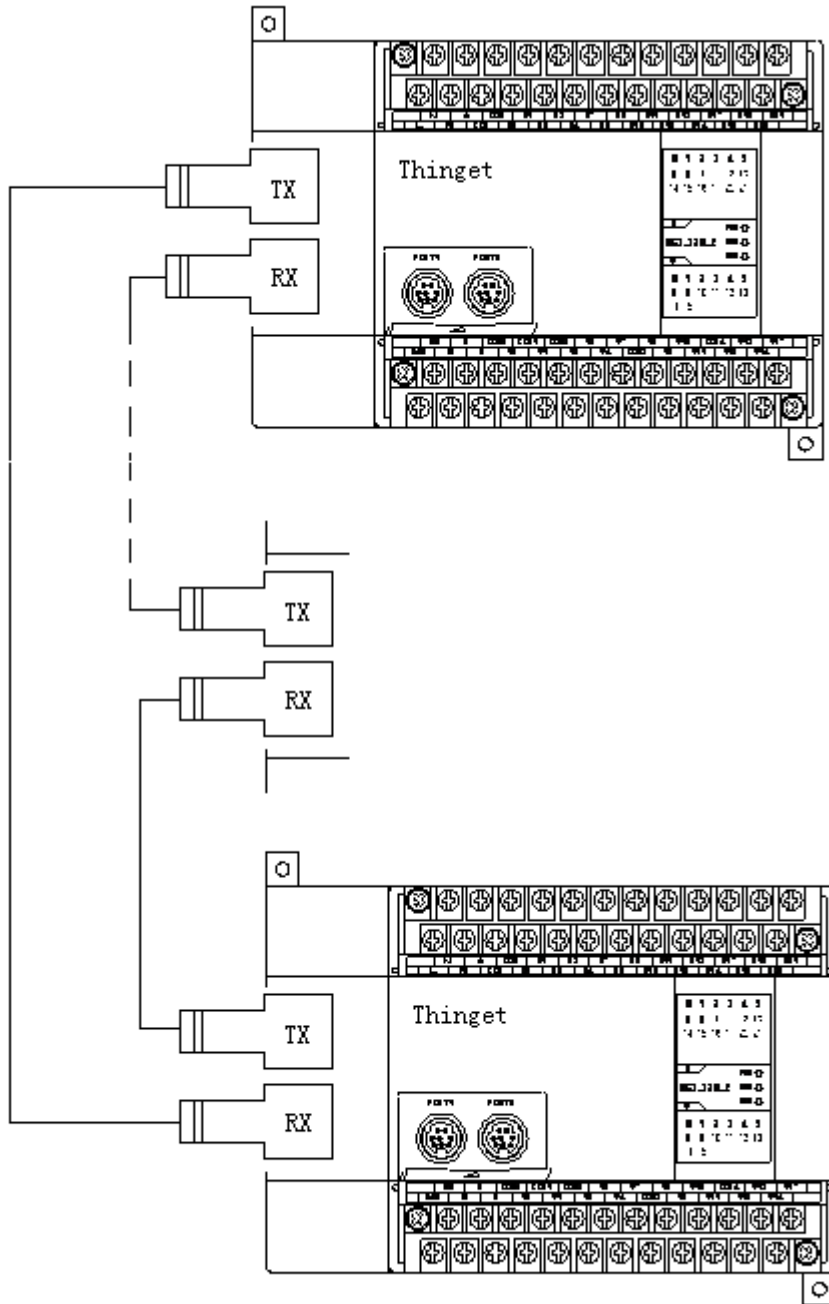

Connect the TX to RX for all the XC-OFC-BDs, all the PLCs will be a loop.

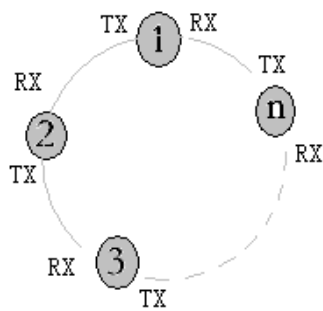

---

### 3. Configuration and settings

#### (1) BD board settings

Connect the PLC with XC-OFC-BD to the PC, open XCPpro software, choose BD serial port:

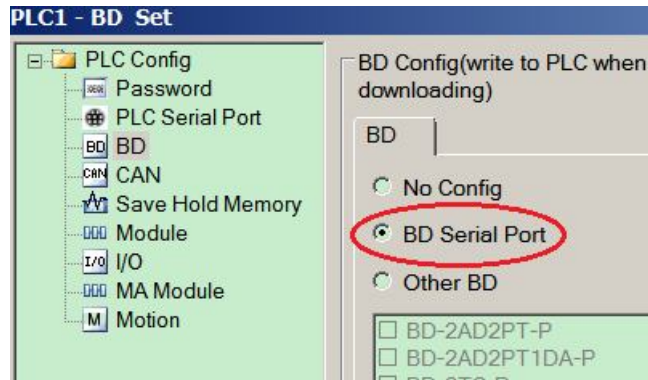

#### (2) Serial port settings

XC-OFC-BD will occupy serial port3 of PLC; it needs to set the port3 in XCPpro software:

- (A) The baud rate of all the port3 in the network must be the same.
- (B) The station number of all the port3 in the network should be different.
- (C) XC3/XC5 support the follow baud rates:  
600Hz,1200Hz,2400Hz,4800Hz,9600Hz,19200Hz,38400Hz,57600Hz,115200Hz,192000Hz,  
288000Hz, 384000Hz, 576000Hz
- (D) XC2/XCM/XCC support the follow baud rates:  
600Hz,1200Hz,2400Hz,4800Hz,9600Hz,19200Hz,38400Hz,192000Hz,256000Hz,384000Hz,  
512000Hz, 768000Hz

Please see the settings in XCPpro software:

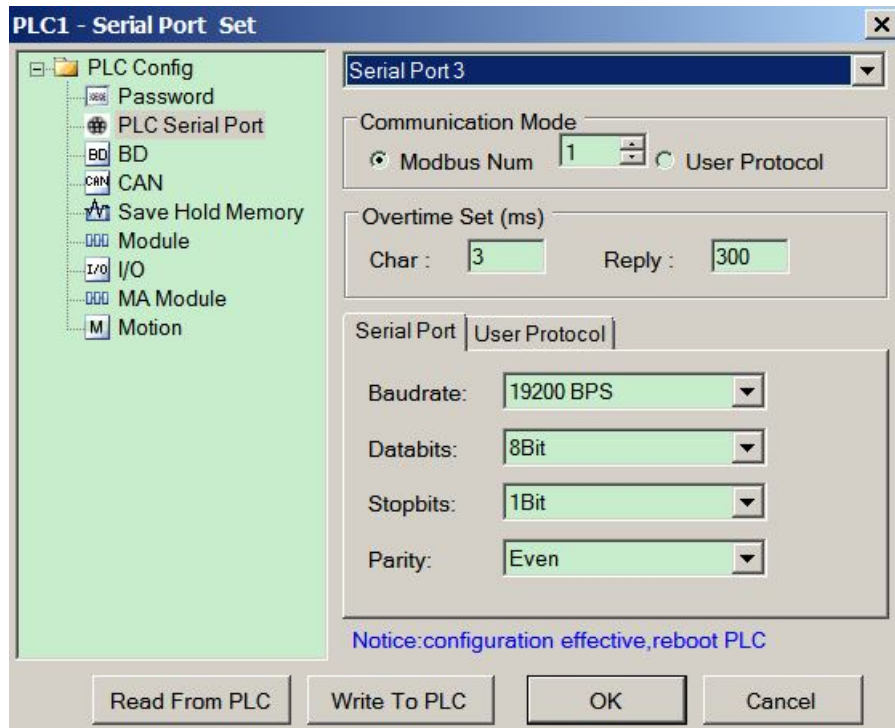

Please set the suitable parameters, click write to PLC, then download an empty program into the PLC. Finally, re-power on the PLC to make it effective. (make sure to choose serial port3 when setting)



## 9. Profibus expansion BD board XC-PBOX-BD

### 1. Summarize

XC-PBOX-BD can be the slave station of Profibus DP. It realizes the interconnection between XC series PLC and Profibus DP system.

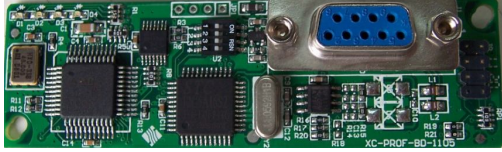

- The theoretical address range of Profibus: 0~127, 127 is broadcast address.
- Up to 32 master stations can be used. The station amounts can up to 127.
- The station No. of XC-PBOX-BD should be in the range of 1-255 and in accord with the slave station no. of Profibus.

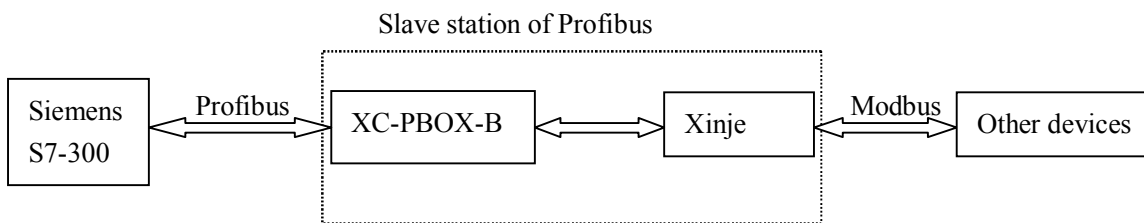

### 2. Terminal resistor

Both ends of the Profibus cable should connect terminal resistor. The terminal resistor can clear the signal reflection in the cable which is caused by resistor discontinuity and mismatching.

### 3. Installation and configuration

(1) Open the cover on the left of the PLC, insert the BD into the pins, fix it with the screws and close the cover.

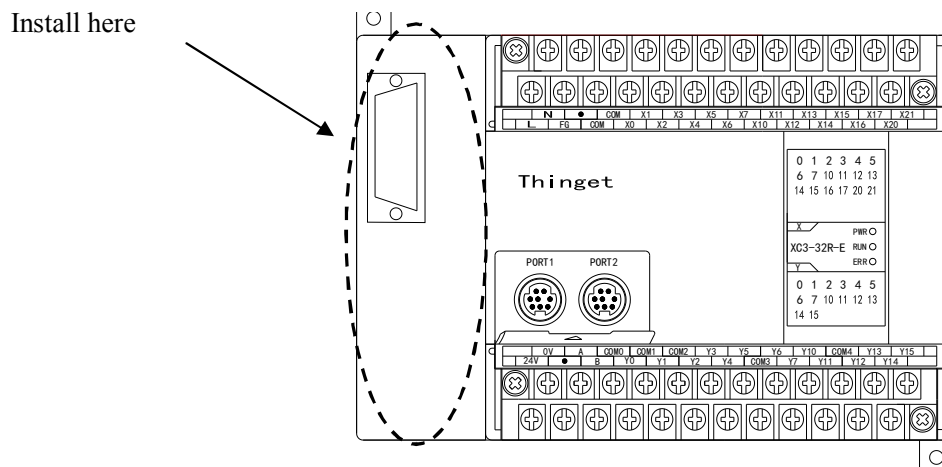

(2) Connect the PLC installed XC-PBOX-BD to the XCPpro software. In the software, click “configure/BD settings”:

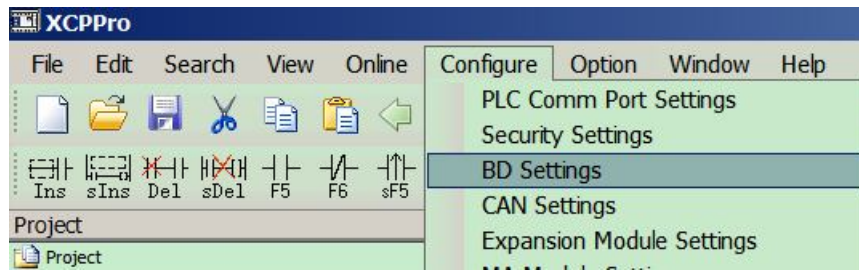

1) Choose “BD serial port”:

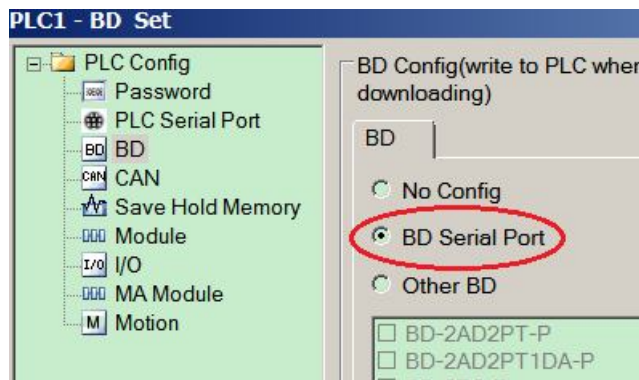

2) Click “PLC serial port”, choose serial port 3 and modbus num. The modbus num should be the Profibus slave station number. Here it is set to 5 for example.

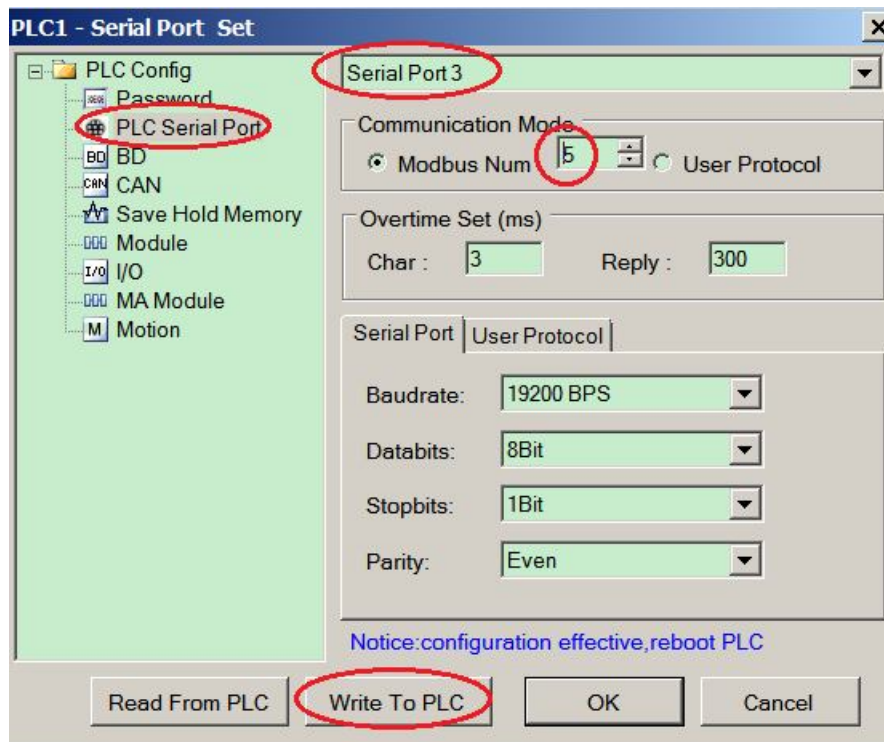

Click “write to PLC”. Then click download



in the software. Finally, please cut the power and power

on again for the PLC and click run



## 4. Wiring

The port of XC-PBOX-BD is the standard Profibus terminal, please see the terminal definition:

XC-PBOX-BD      Profibus DP device

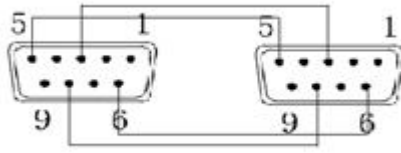

XC-PBOX-BD		Profibus DP device	
Pin	Name	Pin	Name
1			
2			
3	B		(RxD/TxD P)
4			
5	D-GND		GND
6	VP(+)		VCC
7			
8	A		(RxD/TxD N)
9			

5—GND and 6—VCC provide power for terminal resistor. If there is no terminal resistor, please do not connect them.

Note: Only pin 5, 6, 8, 3 need to be connected.

## 5. DIP switch

Please set the baud rate of communicating between XC-PBOX-BD and Xinje PLC via DIP switch.

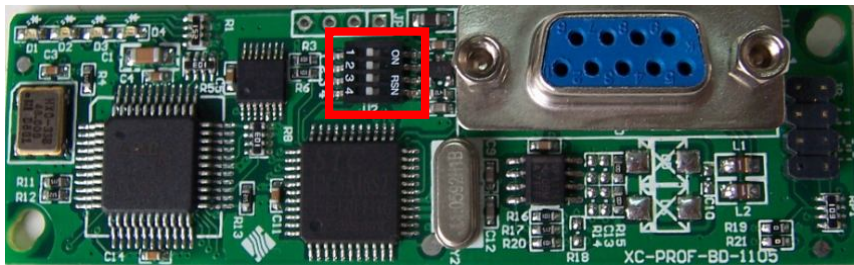

Baud rate (bps)	DIP1	DIP2	DIP3	DIP4
19200	OFF	OFF		
9600	OFF	ON		
38400	ON	OFF		
115200	ON	ON		

Note:

- The default communication parameter is: data bit=8, stop bit=1, even parity.
- Only DIP switch 1 and 2 are valid, 3 and 4 are invalid.

## 6. LED

There are four LED lights on the XC-PBOX-BD.

D4: the light flashes when reading the station No. of PLC serial port3, it always lights when got the station No.

D3: the state of Profibus.

D2: it lights when data is being sent.

D1: it lights when data is being received.

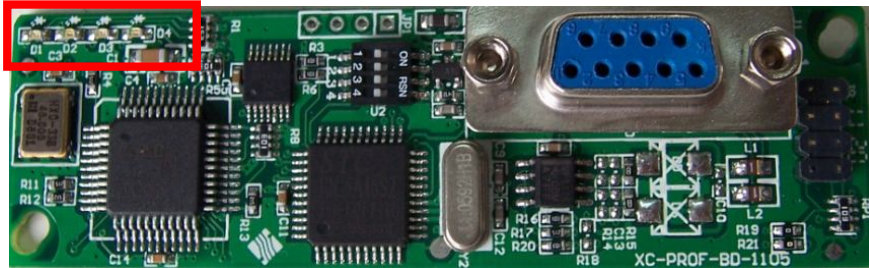

## 7. Operation steps

Please do the following operations if the master station of XC-PBOX-BD is Siemens Profibus-DP device.

- Copy XC-PBOX.GSD to the route of \\.\Step7\S7data\gsd\
- Copy Xinje\_B.bmp to the route of \\.\Step7\S7data\nsbmp\

If the master station is not Siemens products, please copy XC-PBOX.gsd and Xinje\_B.bmp to the folder of gsd and bmp.

Now we take Siemens S7-300 series PLC (315-2AH14-0AB0) as an example to explain the debug process.

Suppose the S7-300 sets ON M0-M7 of Xinje PLC via XC-PBOX-BD. And set double word register (D0,D1) to 12345678, set (D3,D4) to 87654321. And read the value of M20-27 and (D100, D101)(D102, D103).

- (1) Open the Siemens simatic manager software, build a new project.
- (2) Name the project:

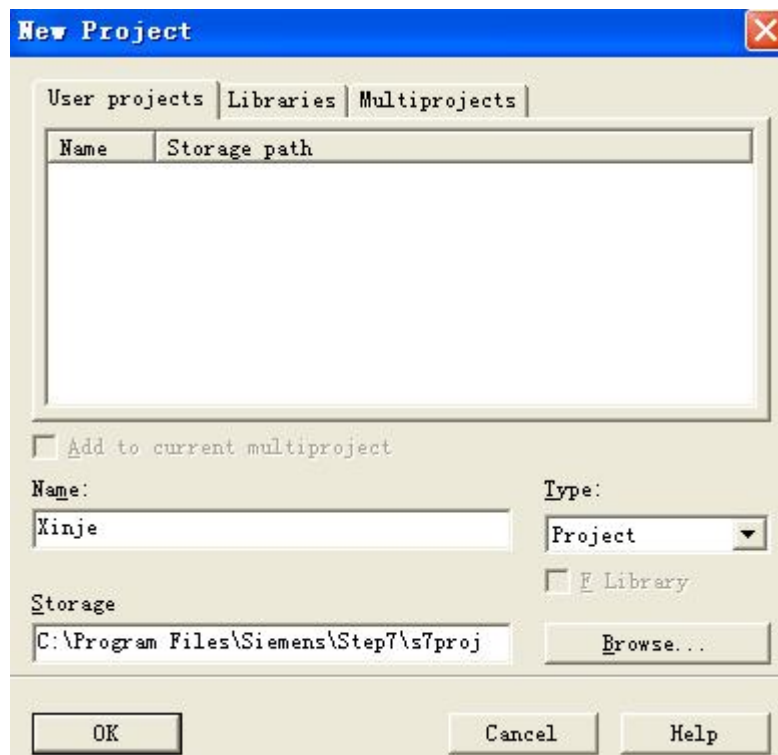

- (3) Insert new object/Simatic 300 station, name it as PBOXOPC:

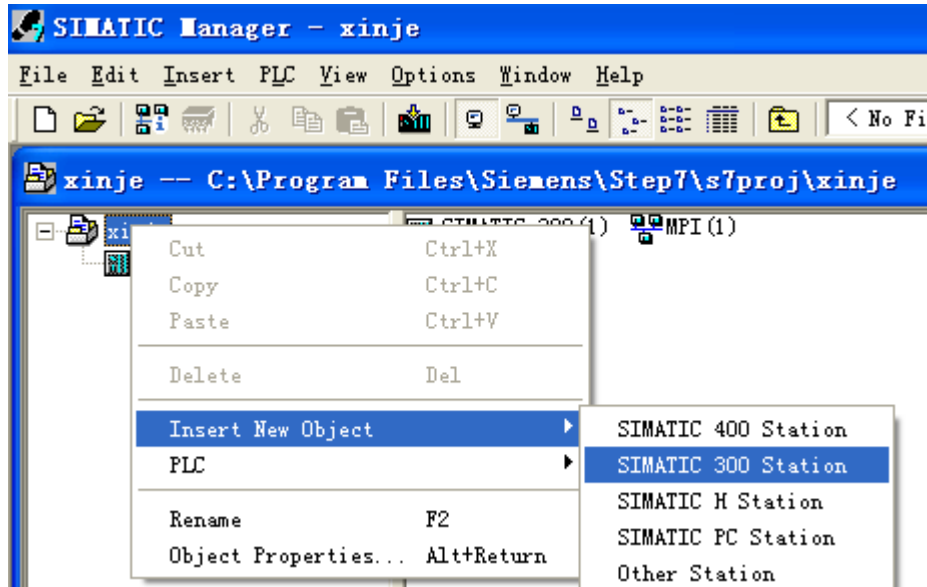

(4) Click PBOXOPC, it will show below window:

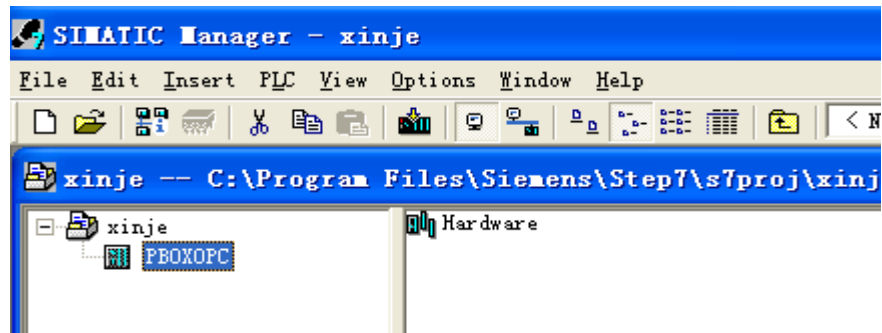

(5) Double click the hardware, you will see below window:

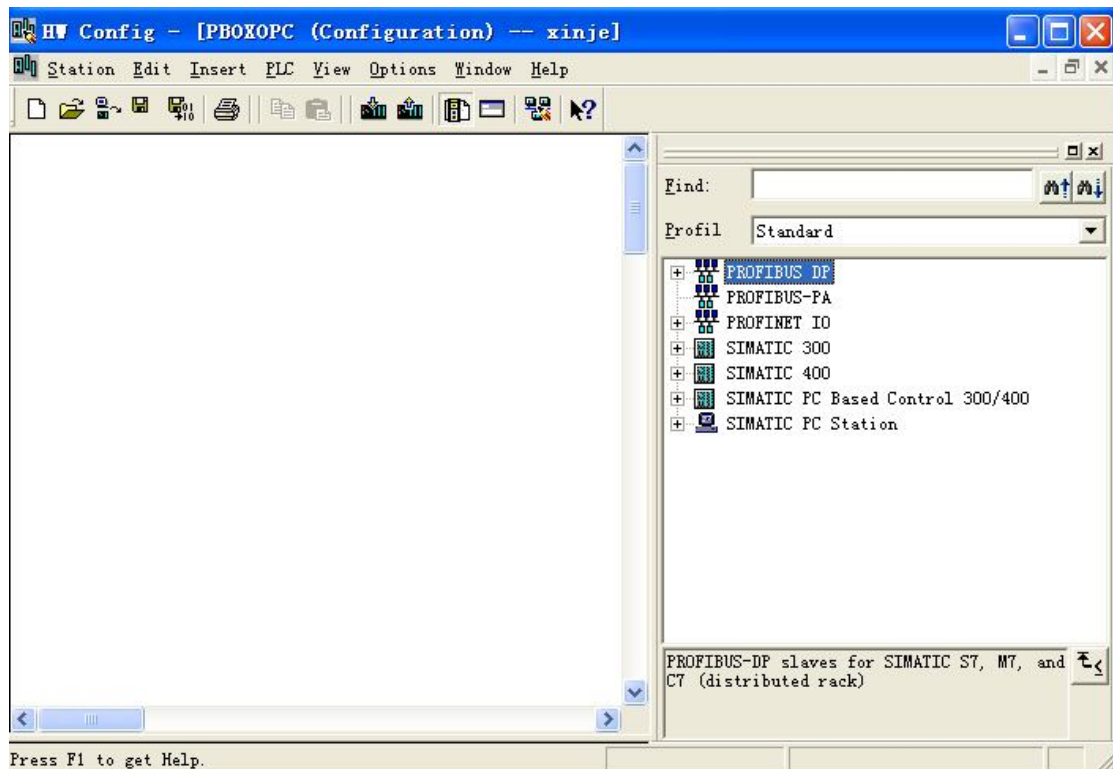



(6) Click Insert/insert object, it will show below window:

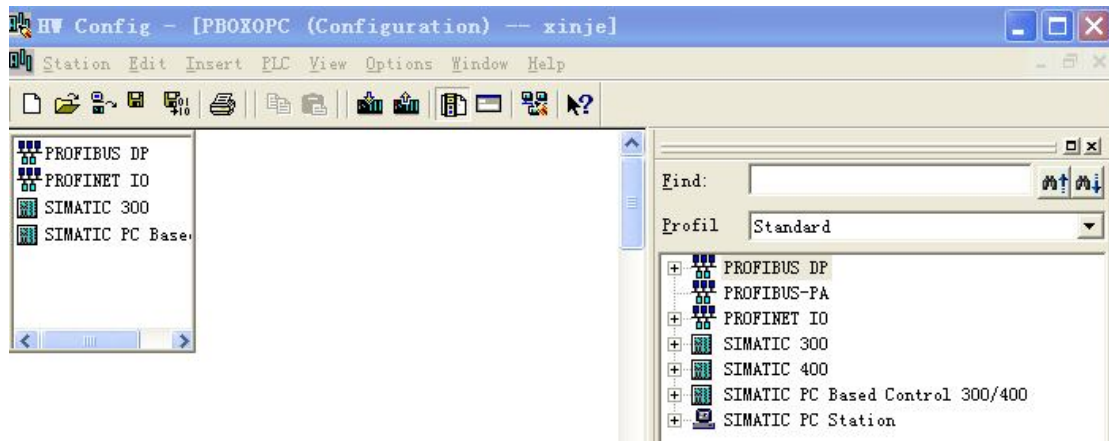

(7) Click "SIMATIC 300", then click "RACK-300", it will show below window:

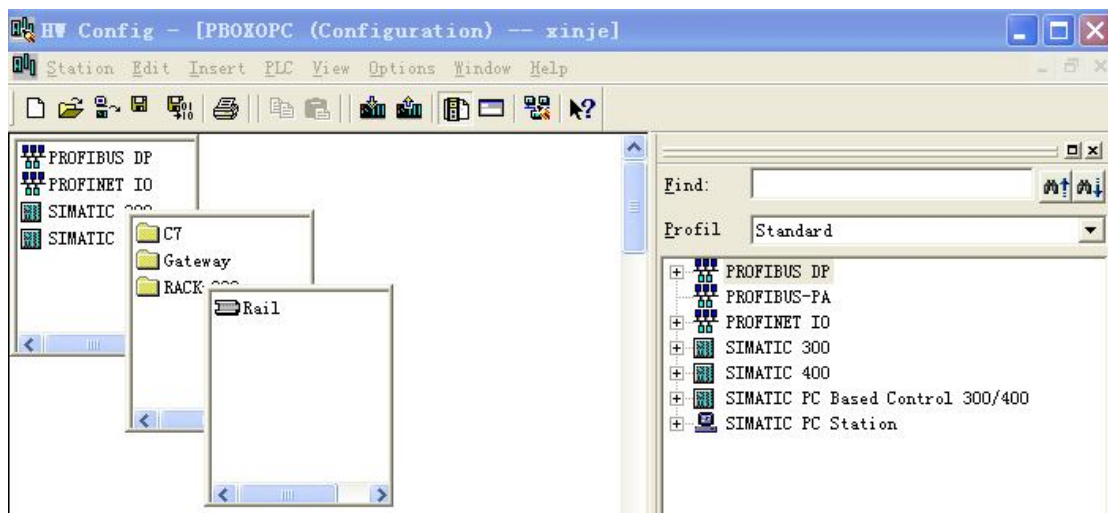

(8) Click Rail, it will show below window:

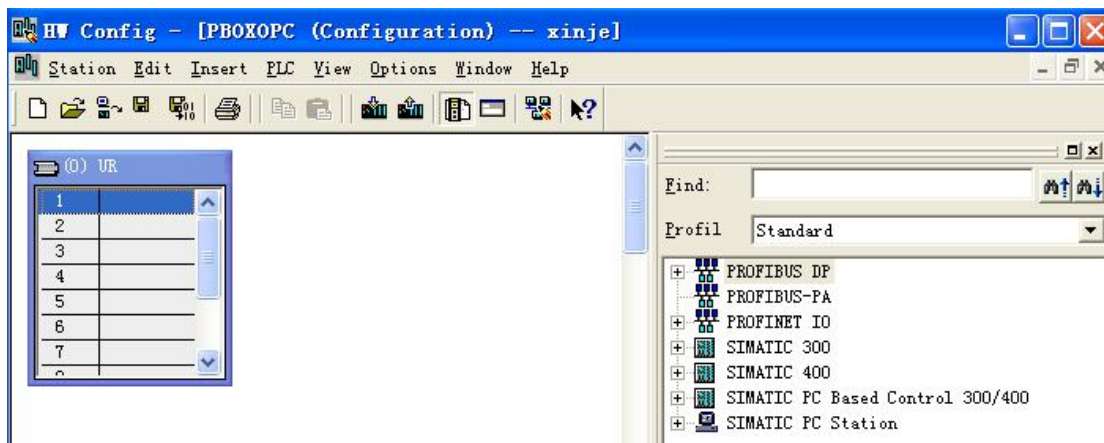

(9) Click Option/update catalog, then do the operations in below window:

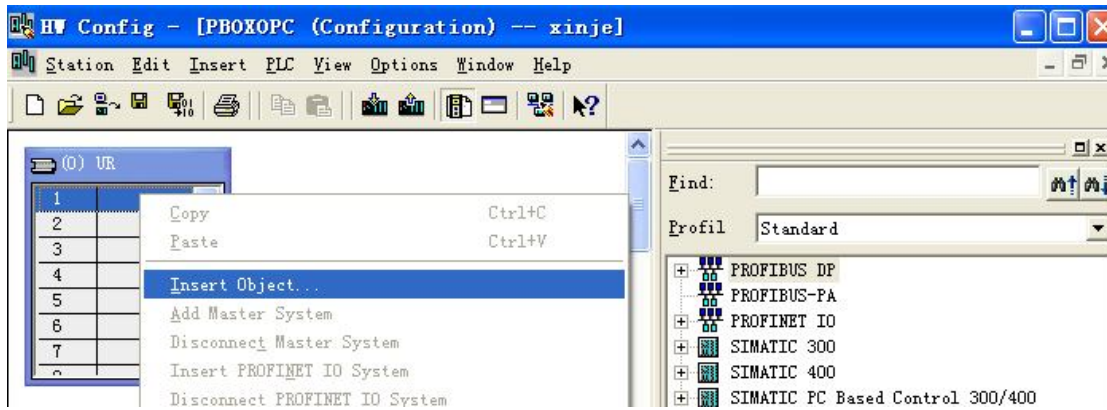

(10) Choose the matched power module for the PLC. Here we choose PS307 2A , CPU 315-2DP\6ES7 315-2AG10-0AB0\V2.6:

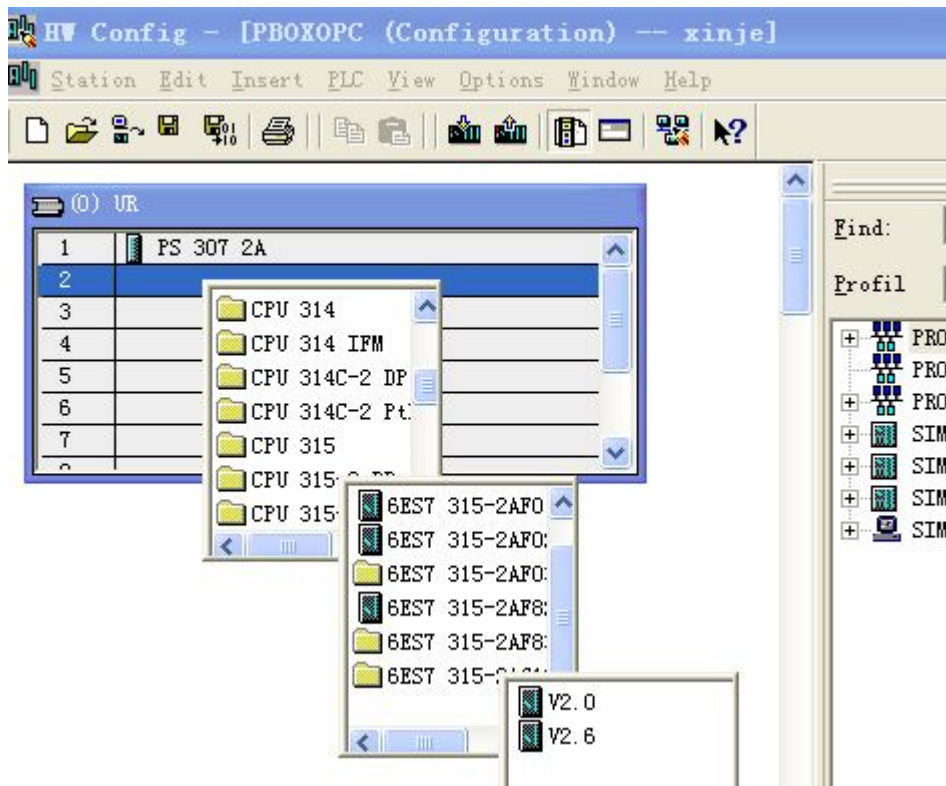

(11) Click v2.6, it will show below window, choose the master station (S7-300) No. of XC-PBOX-BD, here we choose 2. Then click “New...” button in the window:

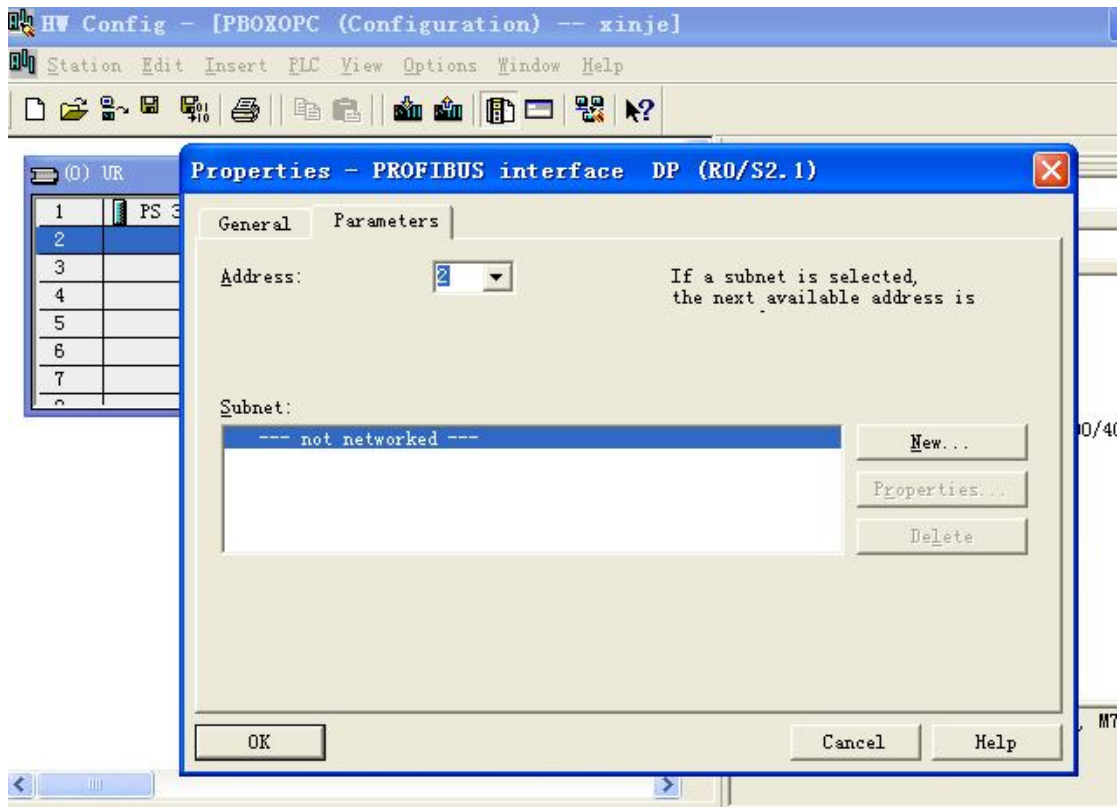

(12) Click “Network settings”, set the transmission rate to 12Mbps.

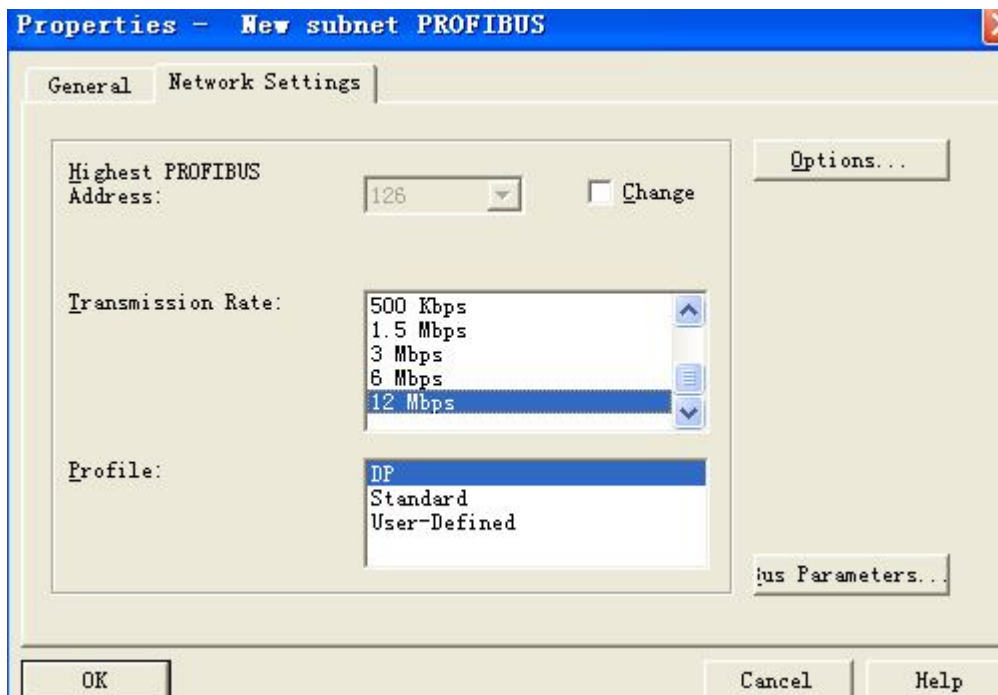

(13) Click PROFIBUS (1): DP master system (1), then choose “Profibus DP\ Additional Field Devices\ Gateway\ PBOX”, double click PBOX, then set the slave station No. of PBOX to 5.



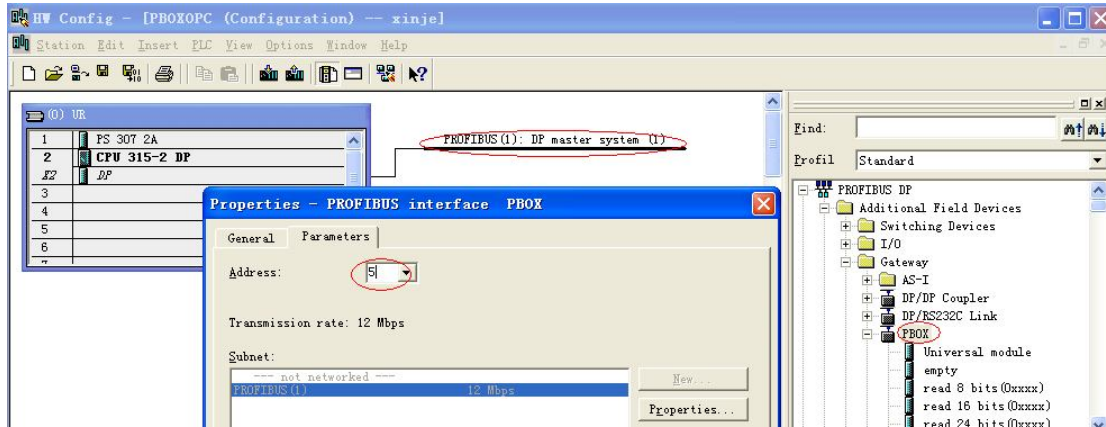

(14) As the chapter 1 said, we copy the file XC-PBOX.GSD to \\.\Step7\S7data\gsd\, and copy the file Xinje\_B.bmp to \\.\Step7\S7data\nsbmp\, now we can see the Xinje station picture in the below window:

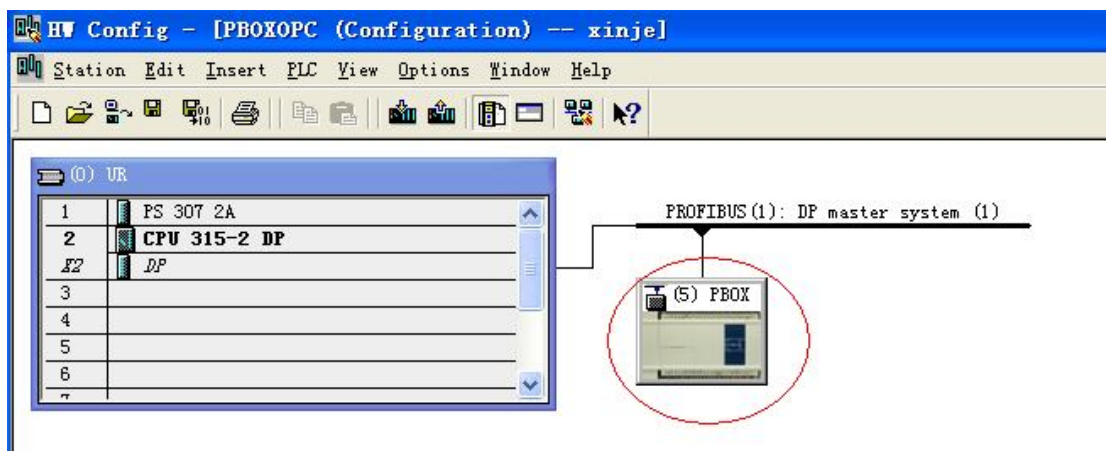

(15) double click the Xinje station picture, it will show below window. Set the data update mode: At every MD end or At MD scan end.

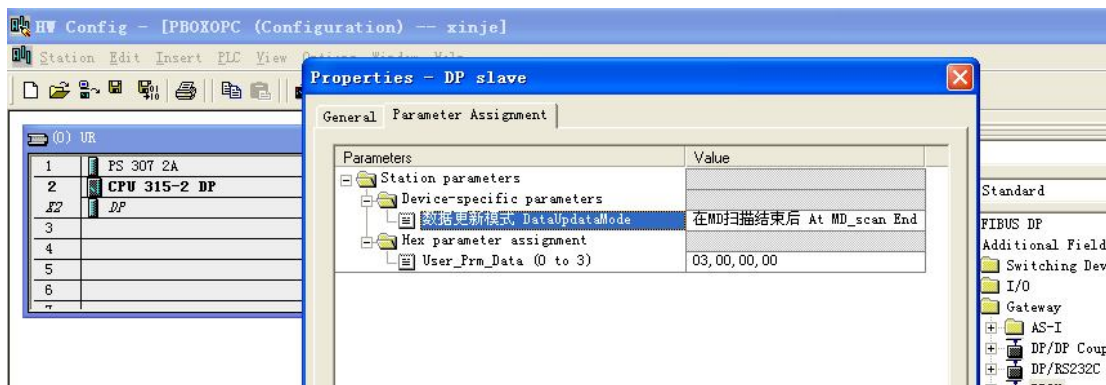

(16) Configure the read and write.



Read: read the value of Xinje PLC to Profibus.

Write: write the value of Profibus to Xinje PLC.

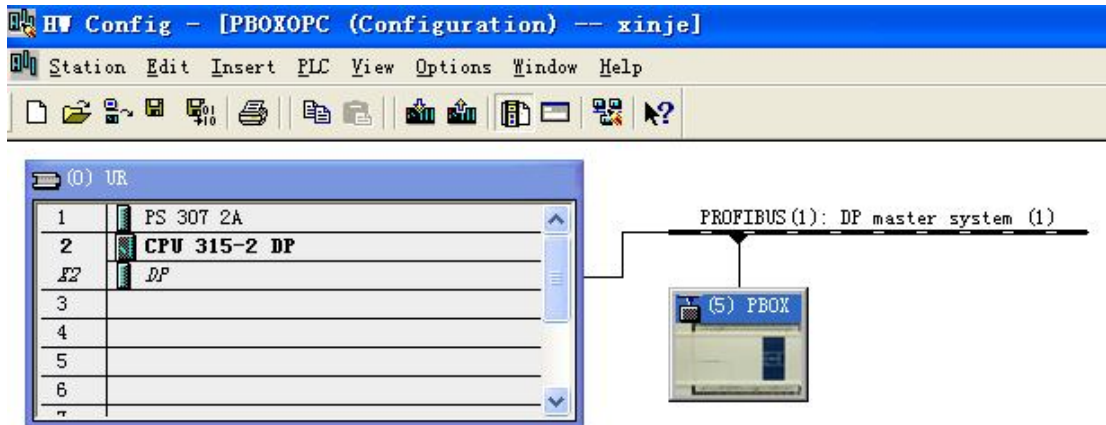
Force single bit and Set single word: write the value of Profibus to Xinje PLC.



S...	DP ID	Order Number / Designation	I Add...	Q Address	Comment
1	8DI	status	0		
2	8DO	controI	0		
3	8DI	read 8 bits (0x1			
4	211	read 2 DWords	256...2		
5	227	write 2 DWords	200...20		
6	8DO	write 8 bits (0	20		
7					
8					

(17) After making the program, click save and compile , then click download to module . Return to below window:

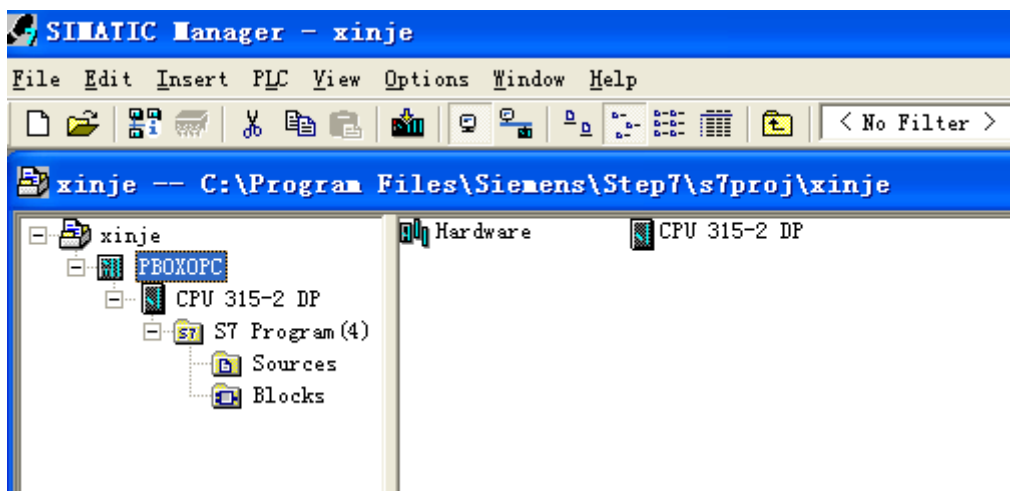

(18) click "Blocks", it will show , double click OB1, it will show below window, then click ok to enter programming window. Then make the program in it.

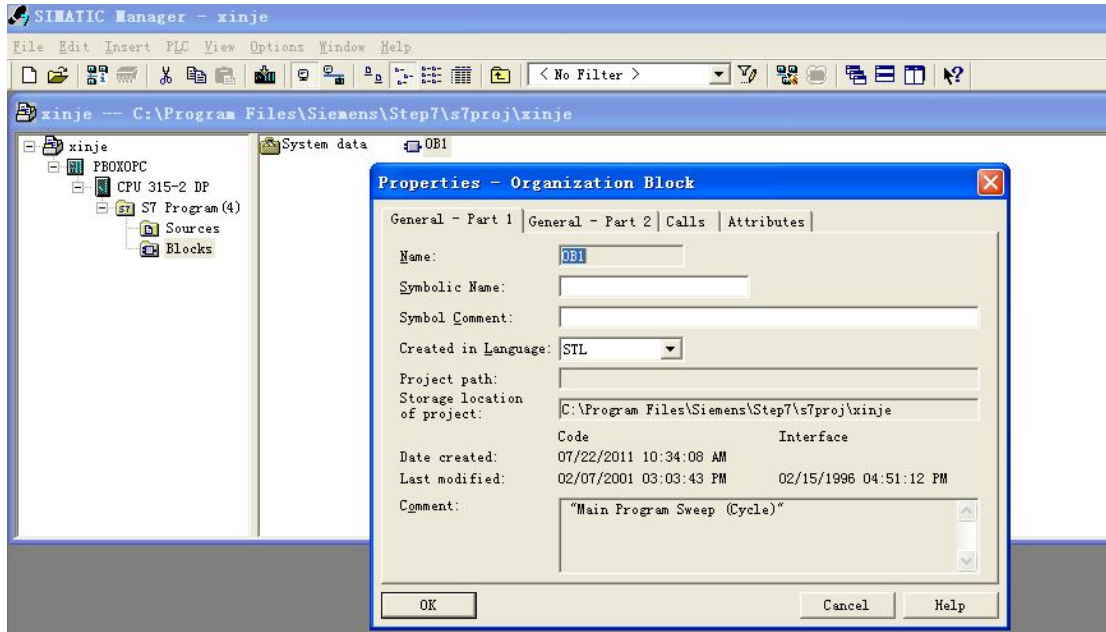

Programming window:

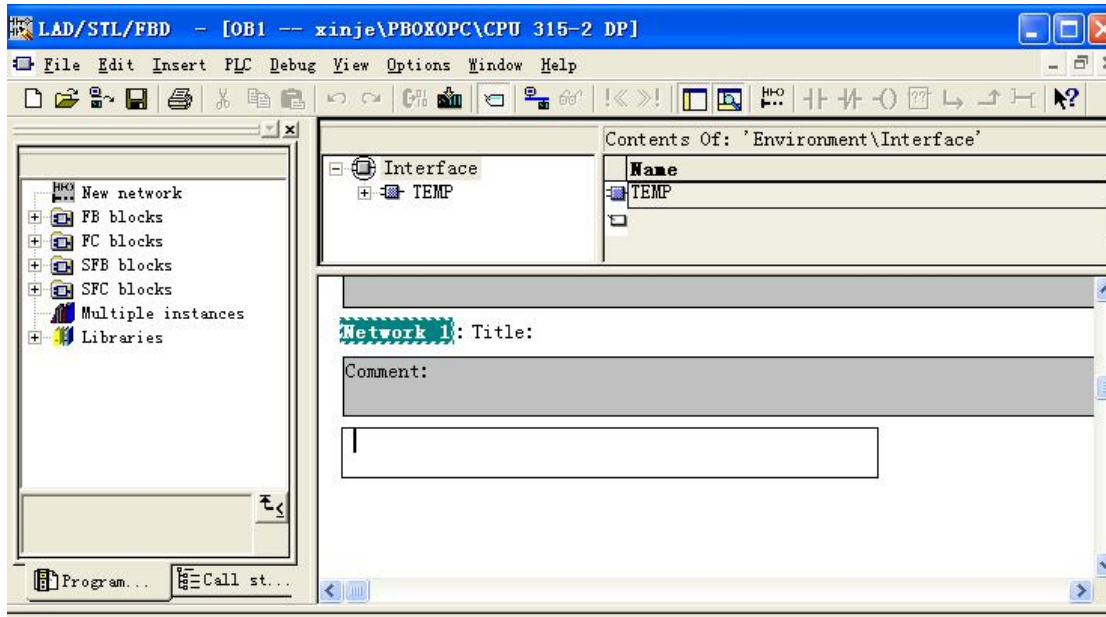

Program:

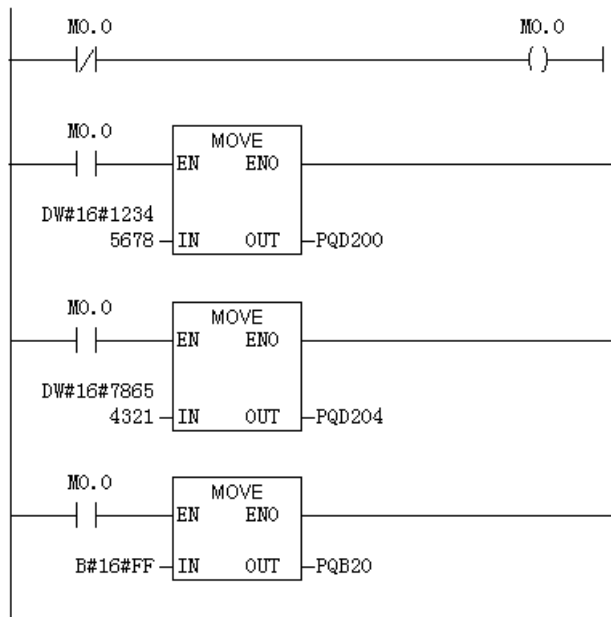

(19) After making the program, save and download to the module. Turn On the RUN switch of S7-300. The SF BF LED is OFF on the S7-300, it means the communication is successful. Then turn off the RUN switch. Now please open the XCPpro software, connect it to the Xine PLC with XC-PBOX-BD (please configure the



XC-PBOX-BD at first in the software). Click free monitor, add the data in the monitor list (see figA).

Then turn on RUN switch of S7-300, the monitor data is shown in figB. (M20-M27,D100 D102 are the data write from S7-300 to XC series PLC.

M0	ON
M1	OFF
M2	ON
M3	OFF
M4	ON
M5	OFF
M6	ON
M7	OFF
M20	OFF
M21	OFF
M22	OFF
M23	OFF
M24	OFF
M25	OFF
M26	OFF
M27	OFF
D0	12345678
D2	87654321
D100	00000000
D102	00000000

FigA

M0	ON
M1	OFF
M2	ON
M3	OFF
M4	ON
M5	OFF
M6	ON
M7	OFF
M20	ON
M21	ON
M22	ON
M23	ON
M24	ON
M25	ON
M26	ON
M27	ON
D0	12345678
D2	87654321
D100	12345678
D102	78654321

FigB

(20) Monitor the data of S7-300. Right click the data needs to monitor:

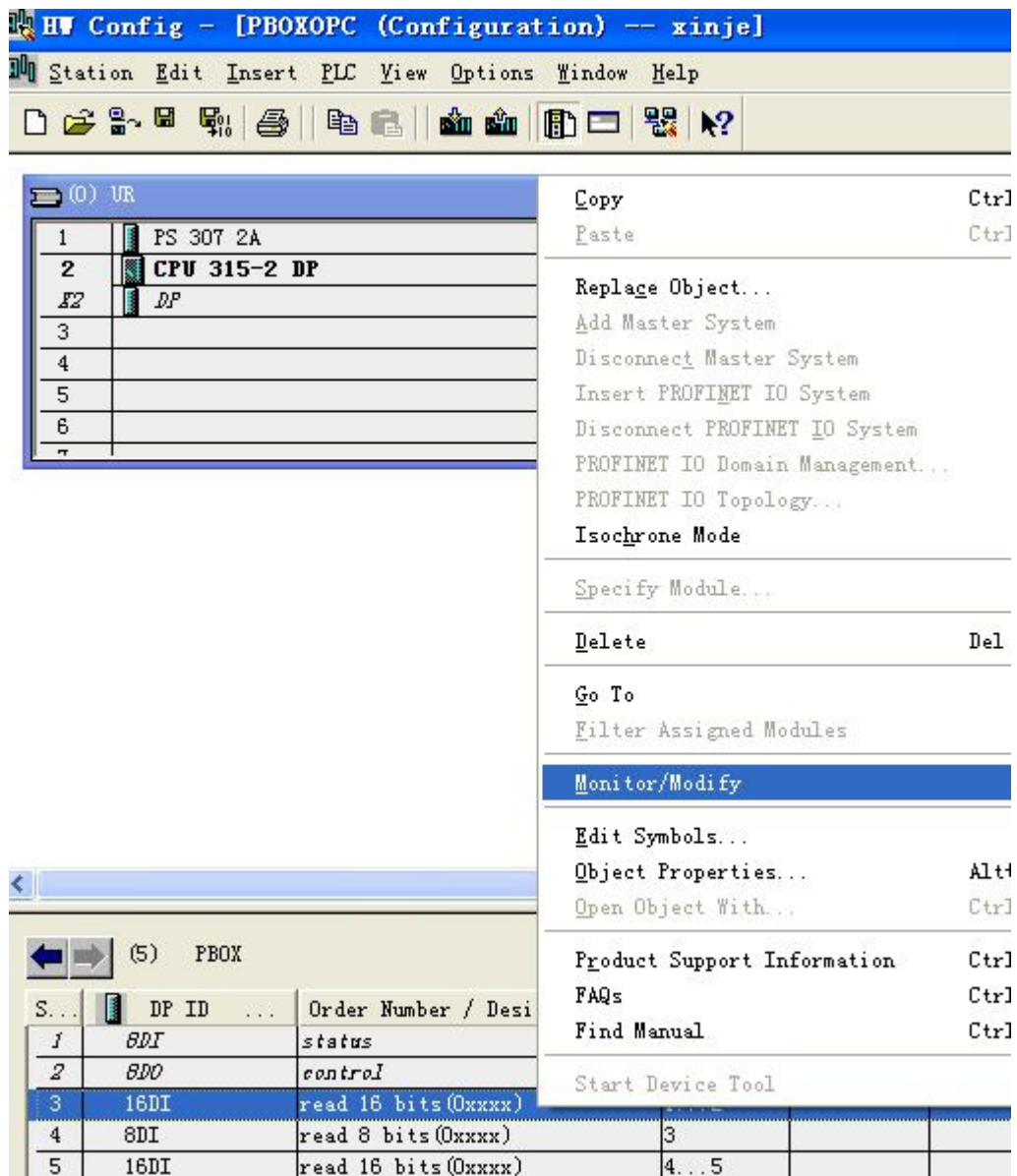

(21) Choose "monitor" to see the data. The data are the same to the setting data in XC series PLC.

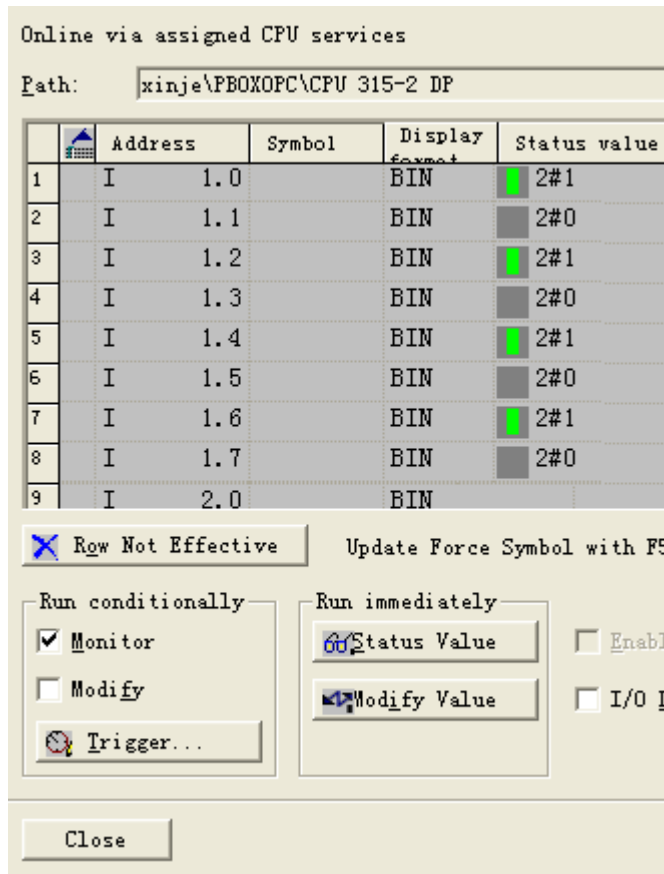

(22) Monitor the Read 2 Dwords with the same way:

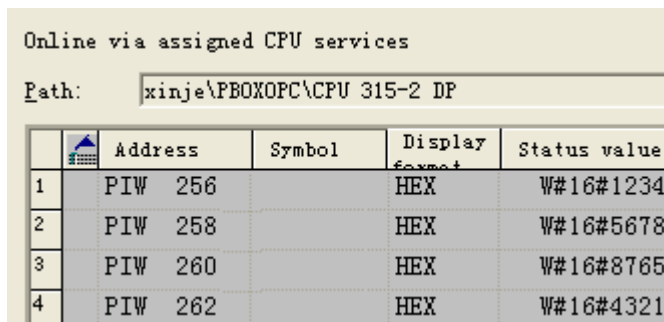

### 8. Notes

1. The Xinje PLC only can be slave station with XC-PBOX-BD. XC-PBOX-BD only can be used with Xinje PLC. Please choose the Xinje PLC which can expand BD module.
2. After configuration of the XC-PBOX-BD, please re-power on it.
3. The station No. in the PLC should be accord to the Profibus slave station No., especially for SCADA application.

The logo for XINJE, featuring the word "XINJE" in a bold, blue, sans-serif font. The letter "X" is stylized with a sharp, angular design.

**信捷科技电子有限公司**

江苏省无锡市蠡园开发区

创意产业园 7 号楼四楼

邮编： 214072

电话： (0510)85134136

传真： (0510)85111290

**Xinje Electronic Co., Ltd.**

4th Floor Building 7,Originality Industry  
park, Liyuan Development Zone, Wuxi

City, Jiangsu Province 214072

Tel: (510)85134136

Fax: (510)85111290